

**MODIS™**

# **Display User Manual**

**August 2009**

**ZEEMS300N Rev. A**

---

## **Trademarks Acknowledgements**

Snap-on, Scanner, Fast-Track, and MODIS are trademarks of Snap-on Incorporated.  
All other marks are trademarks or registered trademarks of their respective holders.

## **Copyright Information**

©2009 Snap-on Incorporated

All rights reserved.

## **Disclaimer**

The information, specifications and illustrations in this manual are based on the latest information available at the time of printing.

Snap-on reserves the right to make changes at any time without notice.

## **Visit our website at:**

[www.snapon.com/solus](http://www.snapon.com/solus) (North America)

[snapondiag.com](http://snapondiag.com) (Europe)

[sun-diagnostics.com](http://sun-diagnostics.com) (Europe)

## **For Technical Assistance**

CALL 1-800-424-7226 (North America)

CALL +44 (0) 845 601 4736 (United Kingdom)

E-mail [DiagnosticsUKproductsupport@snapon.com](mailto:DiagnosticsUKproductsupport@snapon.com) (United Kingdom)

For technical assistance in all other markets, contact your selling agent.

---

# Safety Information

For your own safety and the safety of others, and to prevent damage to the equipment and vehicles upon which it is used, it is important that the accompanying *Safety Information* be read and understood by all persons operating, or coming into contact with, the equipment. We suggest you store a copy the book near the unit in sight of the operator

This product is intended for use by properly trained and skilled professional automotive technicians. The safety messages presented throughout this manual are reminders to the operator to exercise extreme care when using this test instrument.

There are many variations in procedures, techniques, tools, and parts for servicing vehicles, as well as in the skill of the individual doing the work. Because of the vast number of test applications and variations in the products that can be tested with this instrument, we cannot possibly anticipate or provide advice or safety messages to cover every situation. It is the automotive technician's responsibility to be knowledgeable of the system being tested. It is essential to use proper service methods and test procedures. It is important to perform tests in an appropriate and acceptable manner that does not endanger your safety, the safety of others in the work area, the equipment being used, or the vehicle being tested.

It is assumed that the operator has a thorough understanding of vehicle systems before using this product. Understanding of these system principles and operating theories is necessary for competent, safe and accurate use of this instrument.

Before using the equipment, always refer to and follow the safety messages and applicable test procedures provided by the manufacturer of the vehicle or equipment being tested. Use the equipment only as described in this manual.

Read, understand and follow all safety messages and instructions in this manual, the accompanying safety manual, and on the test equipment.

## Safety Message Conventions

Safety messages are provided to help prevent personal injury and equipment damage. All safety messages are introduced by a signal word indicating the hazard level.

### **DANGER**

Indicates an imminently hazardous situation which, if not avoided, will result in death or serious injury to the operator or to bystanders.

### **WARNING**

Indicates a potentially hazardous situation which, if not avoided, could result in death or serious injury to the operator or to bystanders.

### **CAUTION**

Indicates a potentially hazardous situation which, if not avoided, may result in moderate or minor injury to the operator or to bystanders.

Safety messages contain three different type styles.

- Normal type states the hazard.
- Bold type states how to avoid the hazard.
- Italic type states the possible consequences of not avoiding the hazard.

An icon, when present, gives a graphical description of the potential hazard.

Example:

 **WARNING**



Risk of unexpected vehicle movement.

- **Block drive wheels before performing a test with engine running.**

*A moving vehicle can cause injury.*

## Important Safety Instructions

For a complete list of safety messages, refer to the accompanying safety manual.

# SAVE THESE INSTRUCTIONS

# Table of Contents

<b>Safety Information</b> .....	<b>iii</b>
<b>Table of Contents</b> .....	<b>v</b>
<b>Chapter 1: Using This Manual</b> .....	<b>1</b>
Conventions.....	1
Bold Text.....	1
Symbols .....	1
Terminology .....	2
Note and Important Messages.....	2
Procedures.....	2
Additional Manuals .....	3
Tool Help .....	3
<b>Chapter 2: Introduction</b> .....	<b>4</b>
Functional Description.....	4
Technical Specifications.....	6
The Stand.....	7
Control Buttons.....	7
<b>Y/✓</b> (Yes) Button.....	7
<b>N/X</b> (No) Button.....	7
Thumb Pad .....	8
Brightness/Contrast (S Button) .....	8
Power Button .....	8
Power Sources .....	8
AC/DC Power Supply.....	8
Vehicle Auxiliary Power Cables.....	9
Scanner Plug-in Cables.....	10
Battery Pack .....	10
<b>Chapter 3: Getting Started</b> .....	<b>11</b>
Supplying Power to the Unit .....	11
AC/DC Power Supply .....	11
Vehicle Auxiliary Power Cables.....	12
Scanner Plug-in Cables.....	13
Battery Pack .....	13
Installing the Battery Pack.....	14
Connecting the AC/DC Power Supply .....	14
Charging the Battery Pack.....	14
Powering On The MODIS™ Unit.....	15
Adjusting Brightness and Contrast .....	15
Setting Up to Print .....	16
Connecting to a Computer.....	16
Powering Off the Unit .....	16

<b>Chapter 4: Navigation .....</b>	<b>18</b>
Startup Screen.....	18
Screen Layout .....	19
Main Body.....	20
Toolbars.....	20
Upper Toolbar .....	20
Lower Toolbar .....	22
Status Bar .....	23
Making Selections .....	23
Easy Scroll.....	24
Screen Messages.....	25
Confirmation Messages.....	25
Warning Messages .....	25
Error Messages.....	25
 <b>Chapter 5: Operations.....</b>	 <b>26</b>
Main Menu.....	26
Scanner .....	26
Component Test.....	27
Component Testing.....	27
Multimeter.....	28
Scope .....	28
Gases .....	29
Save Data.....	29
Identifying Saved Files.....	31
Loading Saved Files .....	31
Editing Saved Files .....	32
Deleting Saved Files .....	33
Copying and Moving Saved Data .....	33
Selecting All Files.....	34
Viewing Saved Data Information.....	34
Setup.....	35
Backing up Saved Files .....	35
Utilities .....	35
Tool Setup.....	36
Gas Bench Setup.....	44
System Tools .....	44
Legacy Software .....	44
HDS Units .....	44
Tool Help.....	45
Easy Scroll .....	45
Charge Battery .....	46
Connect to PC.....	47
Run .....	48
Shop Info.....	48
System Info .....	48
 <b>Chapter 6: Maintenance.....</b>	 <b>50</b>
Disposal.....	50
Cleaning and Damage Inspection .....	50

Prolonging Battery Pack Life ..... 51

Replacing the Battery Pack ..... 51

5-Amp Fuse ..... 51

Fan Filters..... 52

CompactFlash® (CF) Cards ..... 53

Liquid Crystal Display (LCD) ..... 53

**Appendix A: Troubleshooting ..... 54**

**Appendix B: Downloading and Installing Software Updates ..... 56**

Check for Service Upgrades Before Use..... 56

Verifying Minimum PC Requirements..... 56

    Verifying PC System Properties..... 57

Downloading and Installing ShopStream Connect ..... 57

Downloading Service Upgrades ..... 59

    Before You Begin ..... 60

    Installing a Service Upgrade ..... 60

**Index ..... 63**

This manual contains tool usage instructions.

Some of the illustrations shown in this manual may contain modules and optional equipment that are not included on your system. Contact a sales representative for availability of other modules and optional equipment.

## 1.1 Conventions

### 1.1.1 Bold Text

Bold emphasis is used in procedures to highlight selectable items such as buttons and menu options.

Example:

- Press the **Y/✓** button.

### 1.1.2 Symbols

The following types of arrows are used.

The “greater than” arrow (>) indicates an abbreviated set of selection instructions.

Example:

- Select **Utilities > Tool Setup > Date**.

The above statement abbreviates the following procedure:

1. Navigate to the **Utilities** button.
2. Use the Thumb Pad to navigate to and highlight the **Tool Setup** submenu.
3. Use the Thumb Pad to navigate to and highlight the **Date** option from the submenu.
4. Press **Y/✓** to confirm the selection.

The solid arrows (◀, ▶, ▼, ▲) are navigational instructions referring to the four directions of the Thumb Pad.

Example:

- Press the down ▼ arrow.



### 1.1.3 Terminology

The term “select” means highlighting a button or menu item using the Thumb Pad and pressing the **Y/✓** button to confirm the selection.

Example:

- Select **Reset**.

The above statement abbreviates the following procedure:

1. Navigate to and highlight the **Reset** button.
2. Press the **Y/✓** button.

### 1.1.4 Note and Important Messages

The following messages are used.

#### Note

A NOTE provides helpful information such as additional explanations, tips, and comments.

Example:

**NOTE:**

For additional information refer to...

---

#### Important

IMPORTANT indicates a situation which, if not avoided, may result in damage to the test equipment or vehicle.

Example:

---

**IMPORTANT:**

Do not force the CompactFlash<sup>®</sup> card into the slot.

---

### 1.1.5 Procedures

An arrow icon indicates a procedure.

Example:

**To change screen views:**

1. Select **View**.  
The drop-down menu displays.
2. Select an option from the menu.  
The screen layout changes to the format you selected.

## 1.2 Additional Manuals

Tools that work in conjunction with various hardware and software modules have separate manuals available for each of the modules.

## 1.3 Tool Help

Your unit has Tool Help containing reference and procedural information found in this and other tool related user's manuals. From the main menu, access Tool Help on the Utilities menu.

The MODIS™ (Modular Diagnostic Information System) is a handheld device featuring automotive diagnostic modules that provide expert guidance by combining information with test instrumentation to help you diagnose symptoms, codes, and complaints (Figure 2-1).

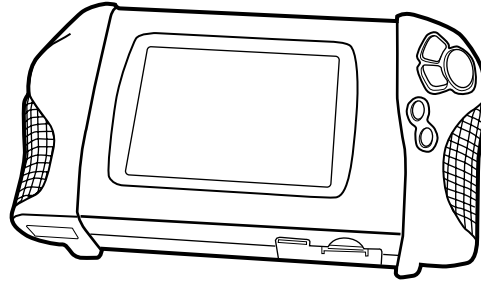

**Figure 2-1** MODIS™ (Modular Diagnostic Information System)

The MODIS™ unit is expandable to let you configure the system to meet your specific needs. Optional modules and accessories can be added to further enable you to diagnose problematic components, connectors, and systems.

## 2.1 Functional Description

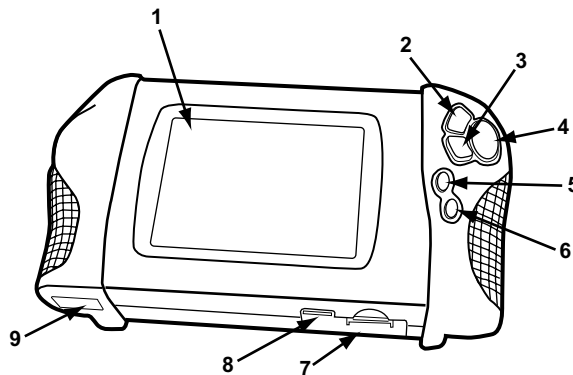

**Figure 2-2** MODIS™ unit front view

- 1— Liquid Crystal Display (LCD)**
- 2— Y/√ (Yes) Button**  
Selects highlighted items.
- 3— N/X (No) Button**  
Exits screens and closes menus.
- 4— Thumb Pad**  
Controls on-screen movement of the highlight.

**5— Brightness/Contrast (S Button)**

Adjusts screen brightness and contrast or performs other user-assigned function.

**6— Power Button**

Turns the MODIS™ display unit on and off.

**7— Battery Pack****8— Fuse**

Protects the internal circuitry.

**9— Video Graphics Array (VGA) Output**

Extends display to an optional external monitor.

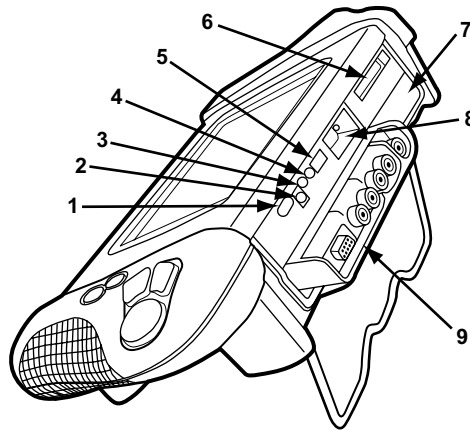

**Figure 2-3** MODIS™ unit top view

**1— Infrared Output**

Sends infrared transmissions to a printer.

**2— DC Power Supply Input****3— DC Supply/Charger Power LED****4— Battery Charging LED**

Indicates the AC/DC power supply is in use when lit.

**5— USB Port**

Use with compliant peripherals such as an optional keyboard, mouse, printer, or mass storage device.

**6— CF (CompactFlash®) Card Slot**

Use for data storage.

**7— Scanner™ Plug-in Slot****8— Serial Port**

Use with optional compliant peripherals, such as the Flexible Gas Analyzer (FGA), or connection to a personal computer.

**9— Lab Scope Plug-in**

## 2.2 Technical Specifications

**Display:**

Liquid Crystal Display (LCD)

640 x 480 resolution

256 Colors

**CompactFlash<sup>®</sup> Card Slot:**

PCMCIA standard compliant

CompactFlash<sup>®</sup> Card

CF Type I

Top slot has I/O support

Side slot is for approved use only (no hot swapping)

**Battery:**

Nickel-metal hydride

**Fuse:**

5A (Buss<sup>®</sup> ATC, Littelfuse<sup>®</sup> ATO, or equivalent)

**Dimensions:**

Height:

7 3/4 inches

197 mm

Width:

14 inches

356 mm

Depth:

3 3/8 inches

86 mm

**Weight (including plug-ins):**

5 lbs. 14 oz.

2579 g

**Operating Temperature Range (ambient):**

At 0 to 90% relative humidity (non-condensing)

32 to 104°F

0 to 40°C

**Storage Temperature (ambient):**

At 0 to 70% relative humidity (non-condensing)

-4 to 122°F

-20 to 50°C

## 2.3 The Stand

The MODIS™ unit has a built-in, metal stand attached to the back. When the stand is not in use, it is secured to the back of the unit by an integrated casing hook. When extended, the stand allows the unit to rest at a 45° angle for hands-free viewing (Figure 2-4).

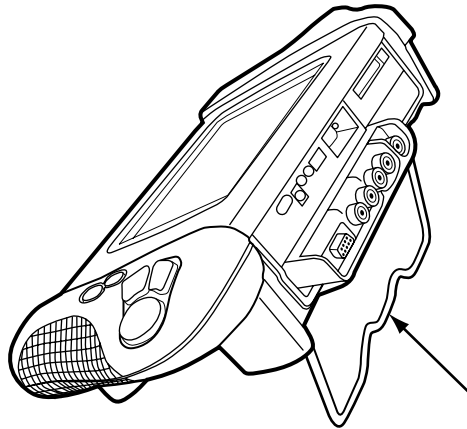

Figure 2-4 MODIS™ unit stand

## 2.4 Control Buttons

There are five control buttons located on the right side handgrip of the MODIS™ unit (Figure 2-2):

### 2.4.1 Y/✓ (Yes) Button

The Y/✓ button performs the following tasks:

- To select the item you highlighted using the Thumb Pad.
- To answer “yes” when a Yes or No choice is given.



**NOTE:**

The Navigation Prompts Tool Setup utility, available in Europe only, can be used to configure the Y/✓ on-screen control reference to display either Y or a check mark. Refer to “Navigation Prompts” for details.

### 2.4.2 N/X (No) Button

The N/X button performs the following tasks:

- To exit a menu or program.
- To close an open list and return to the previous menu.
- To answer “no” when a Yes or No choice is given.
- To return directly to the main menu.

**NOTE:**

The Navigation Prompts Tool Setup utility, available in Europe only, can be used to configure the **N/X** on-screen control reference to display either N or X. Refer to “Navigation Prompts” on page 42 for details.

### 2.4.3 Thumb Pad

The Thumb Pad moves the highlight on-screen and is typically used in combination with the **Y/✓** (Yes) and **N/X** (No) buttons.

### 2.4.4 Brightness/Contrast (S Button)

The Brightness/Contrast button operates as a user-adjustable, multi-function button. The function preference is set up from the Utilities > Tool Setup > Brightness/Contrast Button dialog. Refer to “Brightness/Contrast Button” on page 41 for details.

### 2.4.5 Power Button

The **Power** button turns the MODIS™ unit on and off.

## 2.5 Power Sources

Your MODIS™ unit can receive power from any of the following sources:

- AC/DC power supply
- Vehicle auxiliary power cables (12 volt)
- Scanner Plug-in cables
- Battery pack (rechargeable)

### 2.5.1 AC/DC Power Supply

The MODIS™ unit can be powered from a wall socket using the AC/DC power supply and power cord (Figure 2-5).

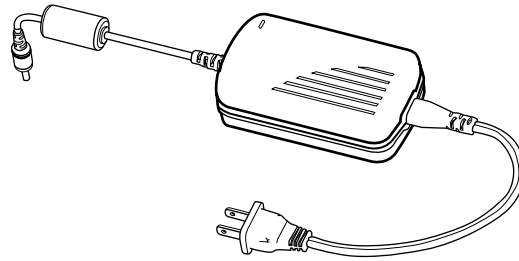

**Figure 2-5** *Sample AC/DC power supply*

When both the AC/DC power supply and the battery pack are installed, the AC/DC power supply is the primary power source. The AC/DC power supply also powers battery pack charging.

Refer to “Charge Battery” on page 46 for details.

## 2.6 Vehicle Auxiliary Power Cables

The MODIS™ unit can be powered from a vehicle using the Lighter Power Cable (Figure 2-6) or the Battery Power Cable (Figure 2-7).



**NOTE:**

When receiving power from the vehicle battery, the Battery Power Cable is used with the Lighter Power Cable.

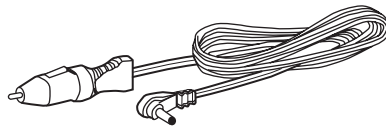

**Figure 2-6** *Sample Lighter Power Cable*

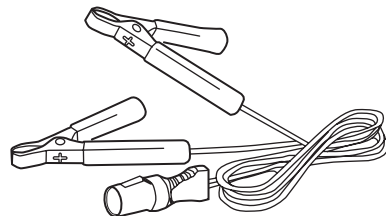

**Figure 2-7** *Sample Battery Power Cable*



**NOTE:**

The vehicle auxiliary power cables will not charge the battery pack.



## 2.7 Scanner Plug-in Cables

The MODIS™ unit can be powered from a vehicle using the Scanner™ Plug-in data cable (Figure 2-8) in conjunction with various vehicle adapters.

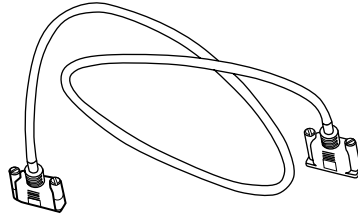
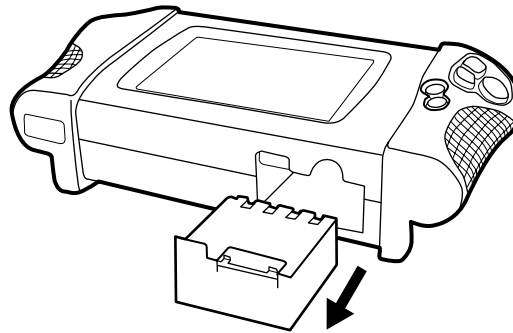

**Figure 2-8** *Sample data cable*

Refer to your manufacturer-specific Vehicle Communication Software (VCS) manual for details.

## 2.8 Battery Pack

The MODIS™ unit can be powered from a rechargeable nickel-metal hydride battery pack located on the bottom of the unit near the right handgrip (Figure 2-9).



**Figure 2-9** *Battery pack location*

When the auxiliary power cables or the Scanner™ Plug-in data cable are in use, the battery pack also works as a backup power source.

For related information, refer to the following sections:

- “Installing the Battery Pack” on page 14
- “Charge Battery” on page 46
- “Replacing the Battery Pack” on page 51

This section explains how to get started using your MODIS™ unit.

## 3.1 Supplying Power to the Unit

Your MODIS™ unit can be powered using the following sources:

- AC/DC power supply
- Vehicle auxiliary power cables
- Scanner Plug-in cables
- Battery pack

## 3.2 AC/DC Power Supply

The AC/DC power supply (included) provides power from a wall socket and is required to charge your battery pack (Figure 3-1).

**NOTE:**

The AC/DC power supply has a separate power cord that plugs into a standard wall socket.

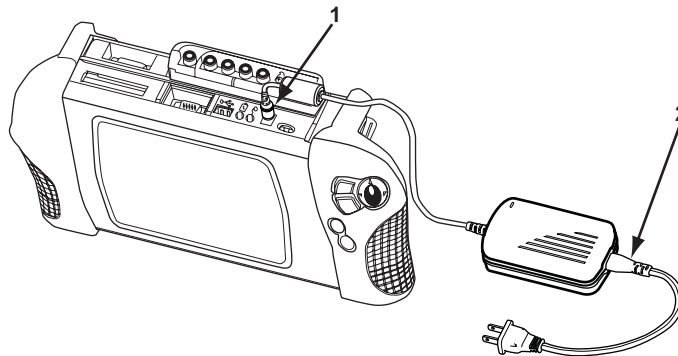

**Figure 3-1** Sample AC/DC power supply connected

- 1— 2.5 mm plug  
2— Oil resistant power cord

**To power the unit using the AC/DC power supply:**

1. Plug the 2.5 mm end of the AC/DC power supply cord into the DC power supply input located on top of your MODIS™ unit.
2. Plug one end of the power cord into the power supply box and the other end into an appropriate wall socket.

- Press the Power button.  
After the start up sequence is complete, the main menu screen displays.

### 3.3 Vehicle Auxiliary Power Cables

The auxiliary power cables can be used to provide power from the vehicle to your MODIS™ unit.

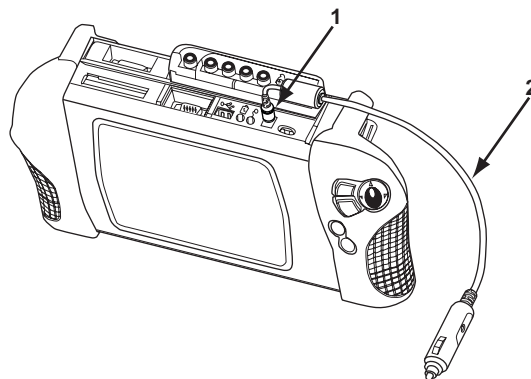

**Figure 3-2** Sample Vehicle auxiliary power cables connected

- 1— 2.5 mm plug
- 2— Lighter Power Cable



**To power the unit using the vehicle auxiliary power cables:**

- Plug the 2.5 mm end of the Lighter Power Cable into the DC power supply input located on top of the MODIS™ unit (Figure 3-2).
- Plug the other end of the Lighter Power Cable into the cigarette lighter or the Battery Power Cable receiver (Figure 3-3).

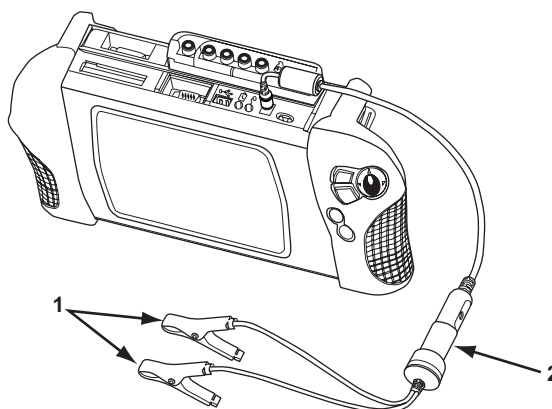

**Figure 3-3** Sample auxiliary power cables connected

- 1— Positive and negative battery terminal clips
- 2— Battery Power Cable receiver

- If the Battery Power Cable is used, clip the other ends of the Battery Power Cable to the positive and negative battery terminals of your test vehicle.

4. Press the Power button.

After the start-up sequence is complete, the main menu screen displays.

---

**IMPORTANT:**

If the unit is powered solely by the vehicle auxiliary power cables, it may reset or shut down if the vehicle voltage drops low enough. When conducting tests that might cause large fluctuations in vehicle voltage, we recommend that you install a fully-charged battery pack as a backup.

---

## 3.4 Scanner Plug-in Cables

The Scanner™ Plug-in data cable in conjunction with various vehicle adapters can provide power from the vehicle to your MODIS™ unit (Figure 3-4).

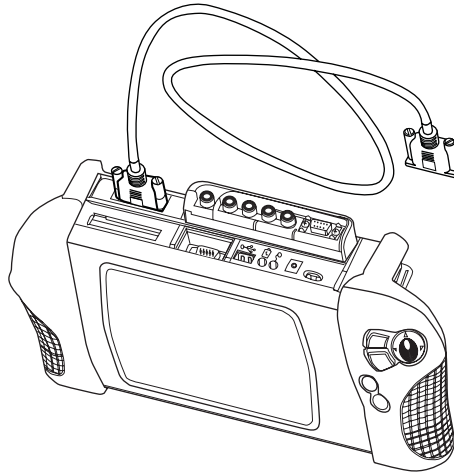

**Figure 3-4** Sample Scanner™ Plug-in data cable

Refer to your manufacturer-specific vehicle communication manual for instructions.

## 3.5 Battery Pack

If you are using the battery pack to supply power for the first time, do the following:



**To charge the battery pack for the first time:**

1. Install the battery pack.
2. Connect the AC/DC power supply.
3. Charge the battery pack in Trickle mode for at least 8 hours. Refer to “Power Management” on page 38 to set the charging mode preference.

## 3.6 Installing the Battery Pack

Follow the instruction below to install the battery pack.



### To install the battery pack:

- Insert the battery pack into the designated slot at the bottom of your unit near the right handgrip (Figure 3-5).

---

### IMPORTANT:

The battery pack only fits one way and will click into place when properly inserted. Do not force the battery pack into the slot.

---

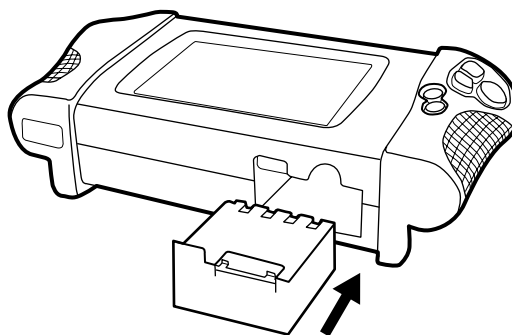

Figure 3-5 Battery pack slot

## 3.7 Connecting the AC/DC Power Supply

The AC/DC power supply is required to charge the battery pack. Refer to “AC/DC Power Supply” on page 11 for the connection procedure.

## 3.8 Charging the Battery Pack

The battery pack must be fully charged before it can be the sole source of power for your MODIS™ unit.

Refer to “Power Management” on page 38 to set your charging mode preference.



### To charge the battery pack:

1. Make sure your battery pack is installed properly.
2. Connect the AC/DC power supply to your MODIS™ unit and plug the other end into an appropriate wall socket.
3. Power on your unit, if needed.



### NOTE:

Your MODIS™ unit must be powered on in order to charge the battery pack.

---

## 3.9 Powering On The MODIS™ Unit

Follow the instructions below to power on your unit.



### To power on your unit:

1. Connect a power supply to your unit.
2. Press the **Power** button.

## 3.10 Adjusting Brightness and Contrast

The **Brightness/Contrast** button on the right handgrip is used to adjust the screen for optimum viewing. Using the Brightness/Contrast Button utility, this button can also be used to perform other functions. See “Brightness/Contrast Button” on page 41 for details.



### To adjust brightness and contrast:

1. Press the **Brightness/Contrast** button.  
The Set Brightness/Contrast dialog box displays (Figure 3-6).

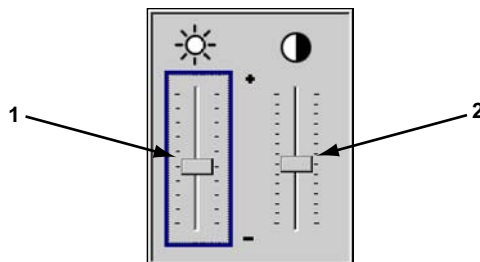

Figure 3-6 Set Brightness/Contrast dialog box

1— Brightness slider control

2— Contrast slider control

2. Select a slider control using the right ► or left ◀ arrows.
3. Press the up ▲ or down ▼ arrow to adjust brightness and contrast.
4. Press **N/X** to close the dialog box.

If you changed the button functionality using the Brightness/Contrast Button utility to do something other than adjust the brightness or contrast, you can either:

- Use the Brightness/Contrast adjustment shortcut.
- Return the Brightness/Contrast button preference.



### Shortcut to adjust brightness and contrast:

1. Simultaneously, press the **Brightness/Contrast** button and the **Power** button.  
The Set Brightness/Contrast dialog box displays (Figure 3-6).
2. Select a slider control using the right ► or left ◀ arrows.
3. Press the up ▲ or down ▼ arrow to adjust brightness and contrast.
4. Press **N/X** to close the dialog box.



**To reset the Brightness/Contrast button preference:**

1. Select **Utilities > Tool Setup > Brightness/Contrast Button**.  
The Brightness/Contrast Button dialog box displays (Figure 3-7).

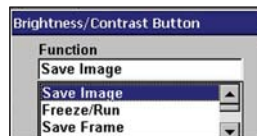

**Figure 3-7** Sample Brightness/Contrast dialog box

2. Select **Brightness/Contrast** from the drop-down list.  
The drop-down lists closes when **Y/✓** is pressed.
3. Press **N/X** to close the dialog box.

## 3.11 Setting Up to Print

Your MODIS™ unit supports various aftermarket printers. Before you can use the **Print** function, you must do the following:

1. Set up the printer.
2. Configure the MODIS™ unit to print.



**To set up the printer:**

- Refer to your printer manufacturer's instructions for powering and paper loading procedures.



**To configure the MODIS™ unit to print:**

- Select a printer manufacturer and port from the **Utilities > Tool Setup > Printer** dialog box. See "Printer" on page 39 for details.

## 3.12 Connecting to a Computer

Connecting your MODIS™ to a computer for file sharing requires the use of the optional ShopStream Connect™ software. ShopStream Connect is a free software program that can be downloaded from the Internet at [software.snapon.com](http://software.snapon.com).

## 3.13 Powering Off the Unit

When you finish using your MODIS™ unit, power it off.

---

**IMPORTANT:**

Before you power off, end all vehicle communication.

---

**To power off the unit:**

1. Press the Power button.  
The “Power off?” confirmation message displays.
2. Press **Y/✓** to turn off the device.  
The Powering Off graphic displays while the system is shutting down. A long beep sounds as the screen goes black.

**Or**

- Press and hold the Power button.  
A series of beeps sounds until there is one long beep and the screen goes black.



This section explains general MODIS™ unit navigation. For detailed information about navigating specific modules and options, see the user’s manual specific to each module.

## 4.1 Startup Screen

The startup screen displays when MODIS™ is first powered up, and when you exit from any test (Figure 4-1). The icons on the left side of the display indicate the various tool operations. Use the up ▲ and down ▼ arrows to select from the list of icons. The icons change as they are selected and deselected (Table 4-1).

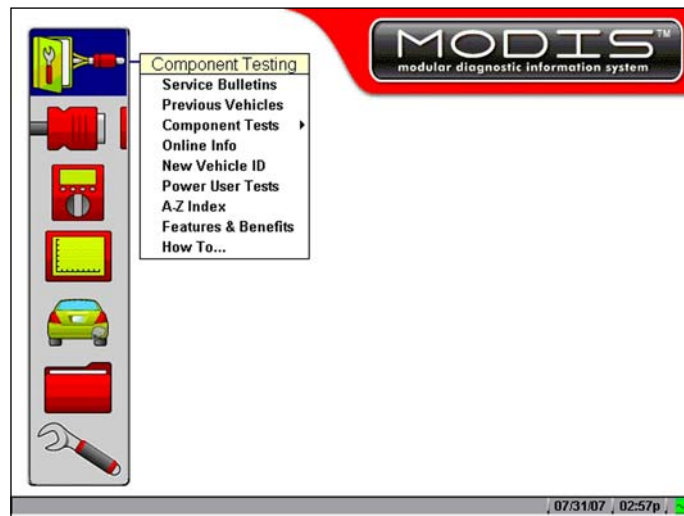
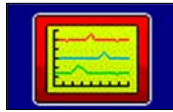
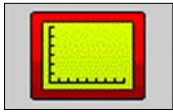







Figure 4-1 Sample startup screen

Table 4-1 Startup screen icons (sheet 1 of 2)

Name	Active	Inactive
Component Tests		
Scanner		
Multimeter		

**Table 4-1** Startup screen icons (sheet 2 of 2)

Name	Active	Inactive
Scope		
Gases		
Save Data		
Utilities		

## 4.2 Screen Layout

MODIS™ screens (Figure 4-2) typically include the following sections:

- The upper toolbar and lower toolbar contain test controls.
- The main body displays test data and may contain multiple sections.
- The status bar contains the date, the time, and the Battery/Charging Status indicator.

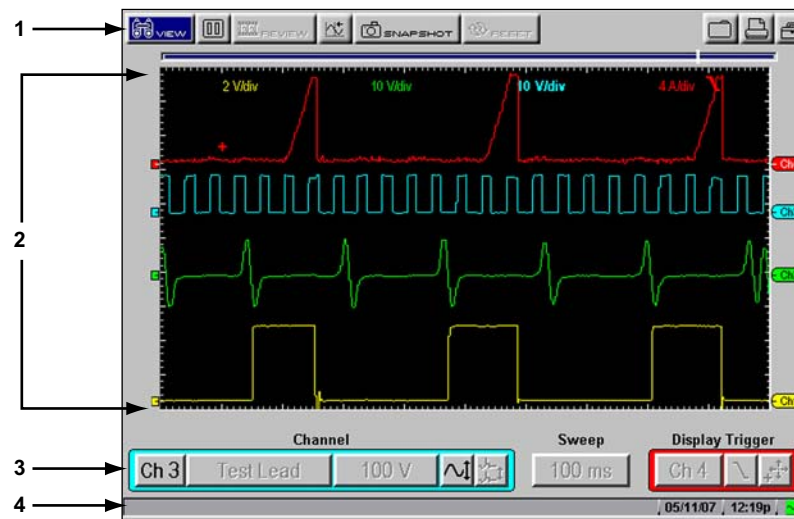

**Figure 4-2** Sample MODIS™ screen layout

- 1— Upper toolbar
- 2— Main body
- 3— Lower toolbar
- 4— Status bar

## 4.3 Main Body

The main body of the screen (Figure 4-2 on page 19) displays test data or other information and may contain multiple sections. Contents vary depending on the module and stage of operations.

## 4.4 Toolbars

Upper and lower toolbars contain test controls that vary depending on the module and stage of operations.

Refer to the module-specific manuals for operating details.



### To navigate MODIS™ toolbars:

1. Use the Thumb Pad to highlight an item.
2. Press **Y/✓** to select it.  
A function is performed or a menu displays.
3. Press the **N/X** button to close menus or exit screens.



### To move between the upper and lower toolbars:

- Press the up ▲ and down ▼ arrows.  
When Easy Scroll is active, press the **N/X** button to move to the upper toolbar (see “Easy Scroll” on page 45 for more information).

### 4.4.1 Upper Toolbar

The upper toolbar (Figure 4-3) controls vary depending on the module and stage of operations. The upper toolbar is used to adjust how information is displayed on the screen. Selecting a button from the toolbar typically opens a dropdown menu of options.

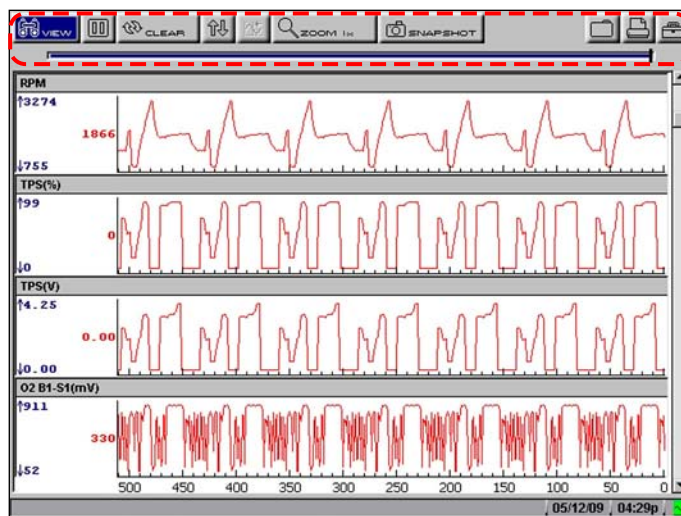





















Figure 4-3 Sample Scanner upper toolbar

The table below details all of the buttons available on the upper toolbar.

**Table 4-2** Upper toolbar controls

Name	Button	Description
Vehicle ID		Lets you identify a vehicle (for Technical Service Bulletins only)
View		Lets you change the way data displays
Scanner		Indicates when the Scanner screen is active in the Scanner mode
Pause		Select to stop data collection and review data
Play		Select to resume data collection, data is captured and stored in the Data Buffer
Cursors		Lets you make measurements of test data
Review		Lets you review paused data
Snapshot		Lets you capture data before and after a problem occurs while driving
Zoom		Lets you change the magnification of the frozen data
Reset		Lets you clear the Min/Max values of digital gauges
Save		Lets you store data and settings
Print		Lets you print the displayed screen
Load		Lets you view saved data files
Edit		Lets you add identifiers and notes to saved data files
Delete		Lets you delete saved data files
Copy		Lets you copy saved data files and save it to another location
Move		Lets you move saved data files to another location
Select All		Lets you highlight all available saved data files at once
Tools		Lets you change the way information appears and where it saves

### Data Buffer

The Data Buffer (Figure 4-4) is located just below the upper toolbar buttons in the Multimeter, Scanner, and Scope modules and indicates how much test data is stored.

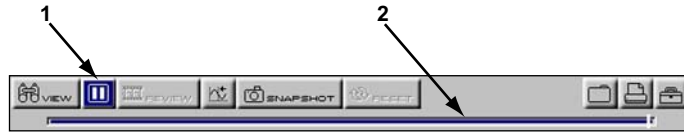

Figure 4-4 Sample Data Buffer

- 1— Pause button
- 2— Data Buffer

When the screen is paused (the Play button displays), the position indicator displays the current frame number and the amount of data on the screen relative to the total data capture (Figure 4-5).



Figure 4-5 Sample Scroll Control with Position Indicator

- 1— Play button
- 2— Position Indicator

The Data Buffer cannot be highlighted or selected.

### 4.4.2 Lower Toolbar

The lower toolbar contains the controls that adjust scope and meter display attributes (Figure 4-6).

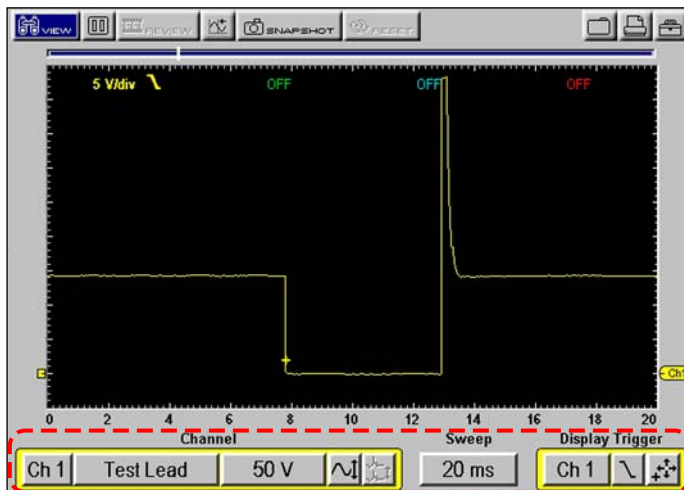













Figure 4-6 Sample scope lower toolbar

The specific controls that display on the lower tool bar vary depending on the active mode and stage of operation. The table below details control options.

**Table 4-3** Lower toolbar controls

Name	Button	Description
Channel number		Lets you select the channel to adjust
Probe		Displays the current test connection for the channel
Scale		Displays the current units of measurement for the channel
Threshold		Sets a condition that triggers test data to display when viewing data as a graph
Signal Zero Offset		Moves a channel's zero (0) position up or down
Raster Spacing		Adjusts the vertical spacing between the cylinders in the Ignition Scope Raster pattern
Calibrate		Indicates when a channel is calibrated or not
Sweep		Sets the amount of test data displayed on-screen
Trigger Type		Sets the criteria used to start the display of data
Slope		Lets you change the Trigger edge from rising to falling
Trigger Position		Moves the trigger point for the specified channel
Sensitivity Adjustment		Lets you adjust the ignition scope cylinder detection sensitivity

## 4.5 Status Bar

The status bar (Figure 4-2 on page 19) is located at the bottom of the screen. This non-selectable display area contains the date, time, and the Battery/Charging Status indicator.

## 4.6 Making Selections

Use the following procedures to navigate and make selections.



### To make selections:

1. Highlight a button or menu option with the Thumb Pad.
2. Press **Y/✓** to confirm the selection.

Selecting some menu items opens a submenu of additional options.



**To make selections from submenus:**

1. Highlight a menu option with an arrowhead after its name to open the submenu (Figure 4-7).

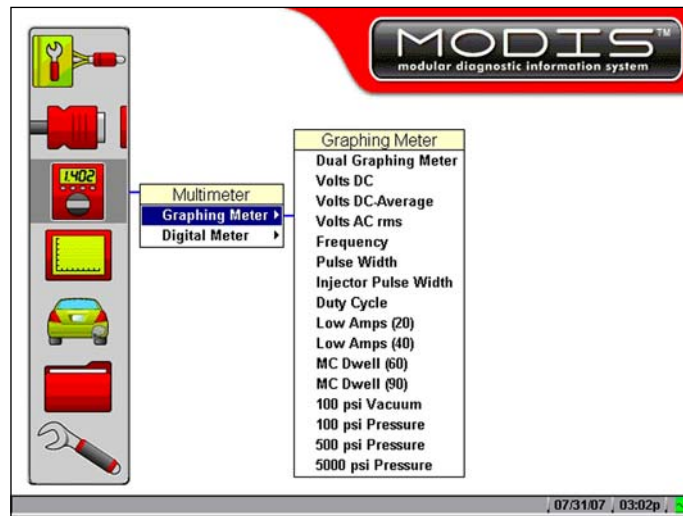

**Figure 4-7** Graphing Meter submenu

2. Press **Y/✓** or right **▶** arrow to move the highlight to the submenu.
3. Select a submenu option.



**NOTE:**

Menu and submenu options vary by market, as well as by what accessories are installed on your MODIS™ unit.



**To exit a selection**

- Press the **N/X** button to return to the previous menu.

## 4.7 Easy Scroll

When active, the Easy Scroll utility simplifies the menu selection process. Instead of using the Thumb Pad to highlight an item and the **Y/✓** button to select it, Easy Scroll lets you use only the Thumb Pad to highlight and select an item.

Using Easy Scroll changes typical navigation in the following ways:

- The up **▲** and down **▼** arrows navigate menus.
- The right **▶** arrow works like the **Y/✓** button to confirm the selection of menu items.
- The left **◀** arrow works like the **N/X** button for cancelling, exiting, and closing menus.

Menus automatically wrap when Easy Scroll is on. When you reach the end of a menu list, the next press of the down **▼** arrow returns you to the top of the list.

The Easy Scroll utility functions differently depending on the module. For example, in modules that have upper and lower toolbars, the up **▲** arrow cannot be used to navigate to the upper toolbar. In

this instance, use either **N/X** or the left ◀ and right ▶ arrows (in a figure-8 pattern) to move out of the lower toolbar.

Refer to “Easy Scroll” on page 45 for information on activating Easy Scroll.

## 4.8 Screen Messages

The MODIST™ unit displays three types of messages:

- Confirmations
- Warnings
- Errors



**To manage on-screen messages:**

- Follow the instructions included with the message.

## 4.9 Confirmation Messages

Confirmation messages:

- Inform you that an action has been completed.
- Inform you when you are about to perform an action that cannot be reversed.
- Continue the action you have started.

When a user-response is not required, the message displays for a short period before automatically disappearing from the screen.

### 4.9.1 Warning Messages

Warning messages inform you when the result of completing the selected action may:

- Cause in an irreversible change.
- Be destructive to data, or result in loss of data.

### 4.9.2 Error Messages

Error messages inform you when an error has occurred, such as:

- When a cable is disconnected.
- When a printer is powered off.
- When a CompactFlash® card is inserted improperly.



This section explains the main menu and how to perform Save Data and Utilities functions.

## 5.1 Main Menu

The Main Menu (Figure 5-1) gives access to all tool operations. The buttons on the left open menus that activate modules or perform general system functions.

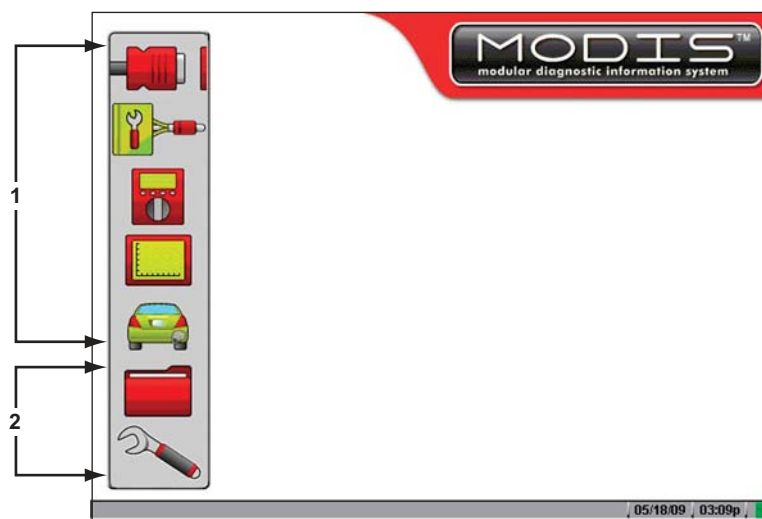

Figure 5-1 Sample main menu screen

1— Module-specific buttons

2— General system buttons

Available buttons and menus vary depending on the modules installed on your MODIS™ unit.

## 5.2 Scanner

The **Scanner** button (Figure 5-2) activates the scan tool module. Menu selections vary by market.

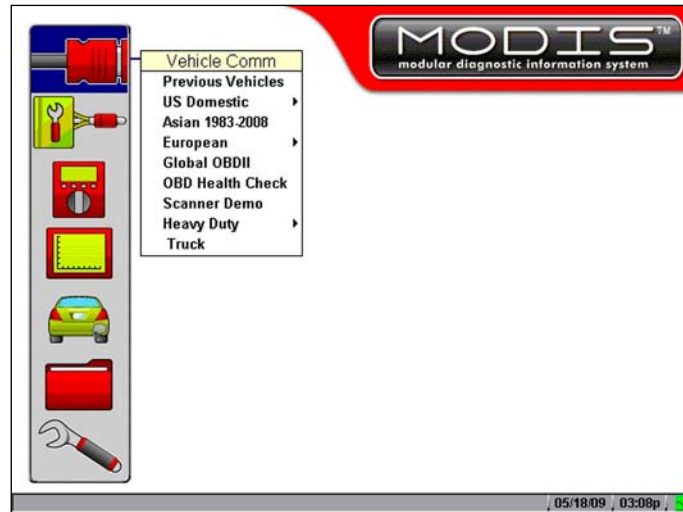

Figure 5-2 Sample Scanner button menu and submenu

Refer to the *MODIS™ Scanner™ Plug-in User Manual* for details.

## 5.3 Component Test

The **Component Test** button on the main screen (Figure 5-3) accesses Component Testing, Service Bulletins, and Online Info.

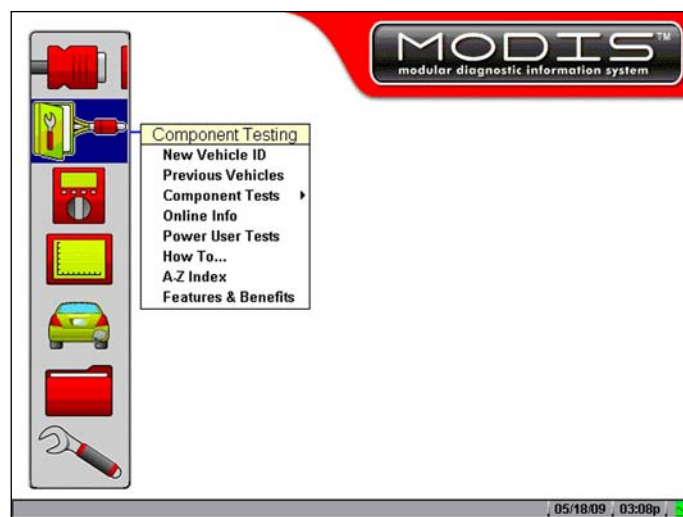

Figure 5-3 Sample Component Test button menu

### 5.3.1 Component Testing

For Component Testing details, refer to the *MODIS™ Component Test User Manual*.

## 5.4 Multimeter

The **Multimeter** button (Figure 5-4) accesses the Graphing Meter and Digital Meter.

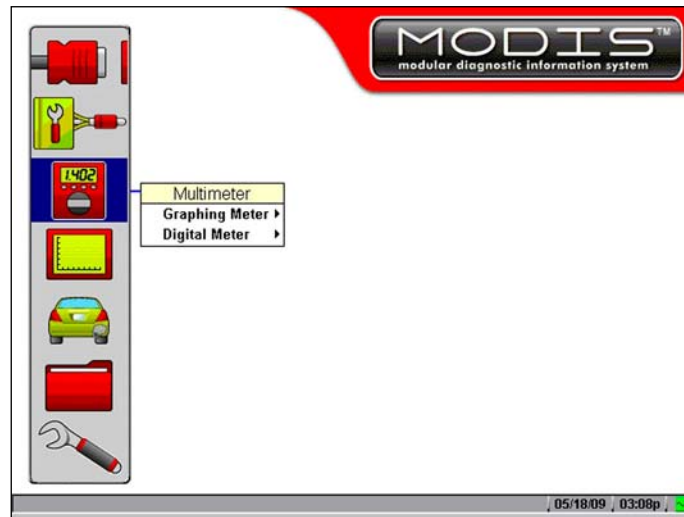
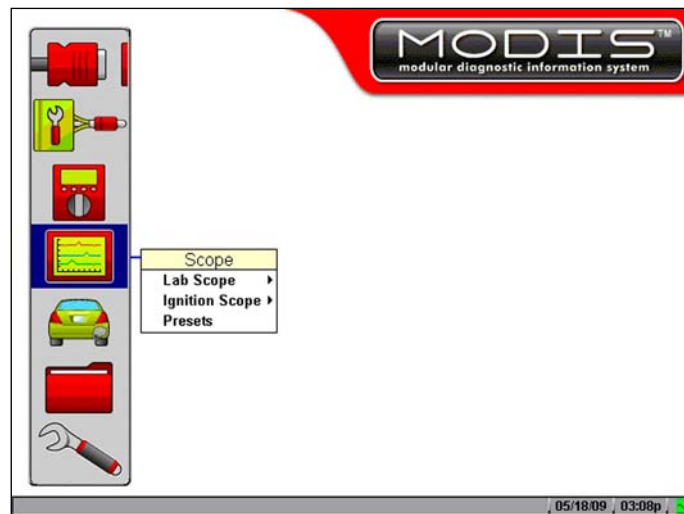

**Figure 5-4** Sample Multimeter button menu and submenu

Refer to the *Lab Scope Plug-in User Manual* for details.

## 5.5 Scope

The **Scope** button (Figure 5-5) accesses the Lab Scope and Ignition Scope.



**Figure 5-5** Sample Scope button menu

Refer to the *Lab Scope Plug-in User Manual* for details.

## 5.6 Gases

Available in North America only, the **Gases** button accesses the vehicle emissions testing software, when the FGA unit is properly connected. The Flexible Gas Analyzer (FGA) is optional equipment.

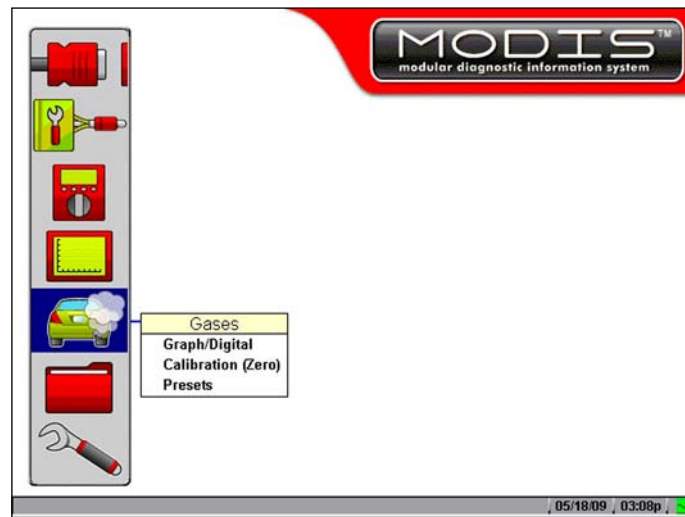

Figure 5-6 Sample Gases button menu

Refer to the *MODIS™ Flexible Gas Analyzer User Manual* for details.

## 5.7 Save Data

The **Save Data** button (Figure 5-7) accesses the Data Management screen.

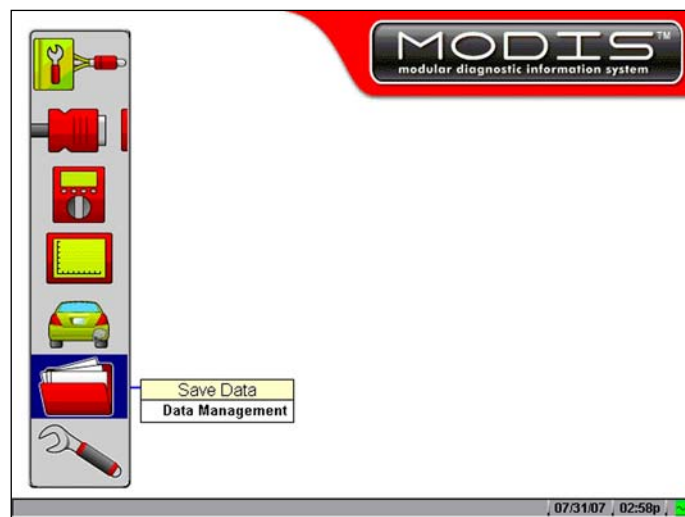

Figure 5-7 Sample Save Data button menu

The Data Management screen (Figure 5-8) lets you manage the storage memory of your unit and your saved files. Data Management is not module-specific.

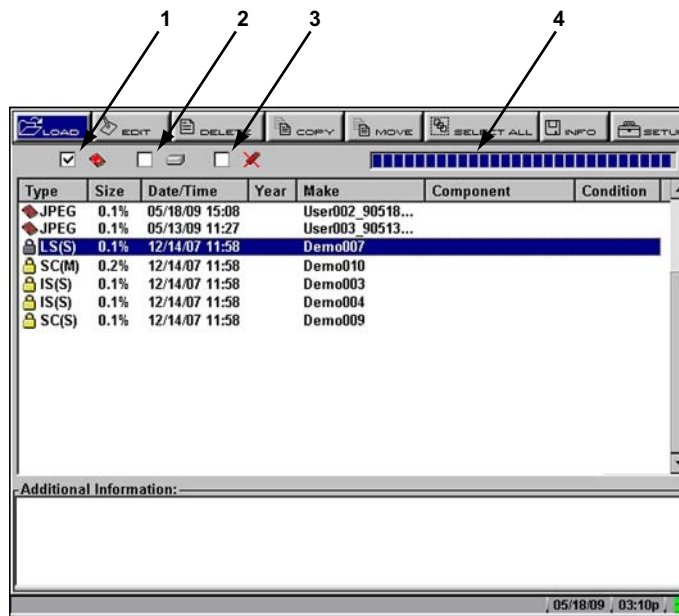

Figure 5-8 Sample Data Management screen

#### 1— Top slot CompactFlash® card indicator

Displays which CF slot is selected in SETUP. The left icon is the Top CF slot and the right icon is Master CF slot (Internal). The Top CF slot icon will be crossed out if there is no card in the slot when it is the selected destination.

#### 2— Internal memory indicator

Refers to the Master CF card in the side slot. The check mark indicates active status

#### 3— USB storage device indicator

This selection is crossed out (as shown) unless a USB mass storage device is connected.

#### 4— Memory usage indicator

Indicates the remaining storage capacity for the active storage memory.

From the Data Management screen, you can perform various management tasks using the following upper toolbar buttons:

- **LOAD** lets you view saved test data.
- **EDIT** lets you add identifiers and notes to saved test data.
- **DELETE** lets you delete saved test data.
- **COPY** lets you copy saved test data and save it to another location.
- **MOVE** lets you move saved test data to another location.
- **SELECT ALL** lets you highlight all available saved test data at once.
- **INFO** opens a window showing the number of files saved and the amount of memory used.
- **SETUP** provides a shortcut to the Save Data utility that lets you set the global location for where files save to and load from, either Internal memory storage or Top CF card memory storage. You can also access this dialog box by selecting **Utilities > Tool Setup > Setup**. Refer to “Save Data” on page 39 for details.

**NOTE:**

Factory-installed files, identified by a lock icon, cannot be edited, deleted, copied, or moved.

## 5.7.1 Identifying Saved Files

Saved files have the following characteristics:

- **Type** is represented as a three-letter identifier, such as LS(M), where “LS” represents the module source (Lab Scope) and “(M)” represents the kind of captured data (Movie).

Data Source Identifiers may include:

- BMP = Bitmap image
- JPG = JPEG image
- SC = Scanner™ Plug-in
- MM = Graphing Multimeter
- LS = Lab Scope
- IS = Ignition Scope
- GB = Gas Bench (North America only)

Data Type Identifiers may include:

- (C) = Preset
- (M) = Movie
- (P) = Snapshot
- (S) = Screen
- **Size** is the percentage of available storage space used.
- **Date/Time** is the date and time that the data was saved.
- **Year** is the vehicle model year.
- **Make** is the vehicle manufacturer.
- **Sensor** is the component tested.
- **Condition** is for good, bad, or unknown status options.

## 5.7.2 Loading Saved Files

The **LOAD** button lets you view saved test data and do the following:

- Modify the data view using the ZOOM, SETUP, CHANNEL NUMBER, SIGNAL ZERO OFFSET, and CURSORS buttons.
- Review data using the REVIEW button if the saved data contains more than one screen.
- Print the screen.

**To load data:**

1. From the main menu, select **Save Data > Data Management**.  
The Data Management screen displays (Figure 5-8).
2. Use the up ▲ and down ▼ arrows to highlight a file from the list on-screen.
3. Use right ► and left ◀ arrows to select **LOAD** from the upper toolbar.

**NOTE:**

If you load a BMP file and want to print it, press **Y/✓**.

**To exit the loaded screen:**

1. Press **N/X** to return to the Data Management screen.
2. Press **N/X** again to return to the main menu.

### 5.7.3 Editing Saved Files

The **EDIT** button lets you add notes to saved test data. You can also tag the data files with Year, Make, Component, and Test Status identifiers.

**NOTE:**

Scanner screen (SP) and Bitmap (BMP) files cannot be edited.

**To edit a saved file:**

1. Plug in a USB keyboard (not supplied) into the USB port on top of the unit.
2. From the main menu, select **Save Data > Data Management**.  
The Data Management screen displays.
3. Use the up ▲ and down ▼ arrows to highlight a file from the list on-screen.
4. Use right ► and left ◀ arrows to highlight **EDIT** in the upper toolbar.
5. Press **Y/✓** to select.

The Edit Saved Data Notation dialog box displays (Figure 5-9).

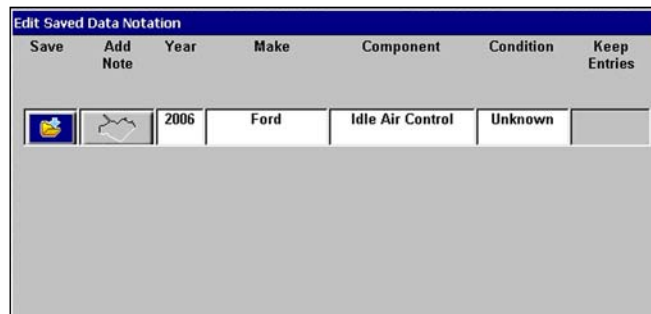

**Figure 5-9** Sample Note added to test data

**NOTE:**

The Add Note button is only active when a keyboard is plugged in.

6. Select the **Add Note** icon.
7. Using a keyboard to type a note (7 lines maximum), then press **Esc** to exit.
8. Select the **Year**, **Make**, **Component**, or **Tested** option.  
A drop-down list displays.
9. Select options from the drop-down lists as appropriate.
10. Select **Save** when you are finished to return to the Data Management screen.

**NOTE:**

The **Keep Entries** options are only available when first saving the file.

**To exit Edit Data screen:**

- Press **N/X** to return to the main menu.

## 5.7.4 Deleting Saved Files

The **DELETE** button lets you delete saved test data.

**To delete files:**

1. From the main menu, select **Save Data > Data Management**.  
The Data Management screen displays.
2. Use the up ▲ and down ▼ arrows to highlight a file from the list on-screen.
3. Use right ► and left ◀ arrows to select **DELETE** from the upper toolbar.  
A confirmation message displays (Figure 5-10).

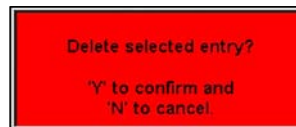

**Figure 5-10** Sample Delete file confirmation message

4. Permanently erase the data from memory by pressing **Y/✓**, or press **N/X** to cancel.

**NOTE:**

Factory-installed files cannot be deleted.

## 5.7.5 Copying and Moving Saved Data

The **COPY** and **MOVE** functions let you transfer saved test data from one CF card to the other.

**To copy or move data:**

1. From the main menu, select **Save Data > Data Management**.  
The Data Management screen displays.
2. From the upper toolbar, select **SETUP**.  
The Save Data dialog box displays.
3. Set **Internal** as the **Save To** option and press **N/X** to close the dialog box.  
The test data saved to the internal memory displays.
4. Use the up ▲ and down ▼ arrows to highlight a file from the list on-screen.
5. Use right ► and left ◀ arrows to select **COPY** or **MOVE** from the upper toolbar.  
A confirmation message displays.



6. Press **Y/✓** to close the message box.  
You return to the Data Management screen.

**NOTE:**

Factory-installed files and files saved on a CF card in the top slot cannot be copied or moved.

## 5.7.6 Selecting All Files

The **SELECT ALL** button highlights all saved data so you can delete, move, or copy all the files at once (Figure 5-11).

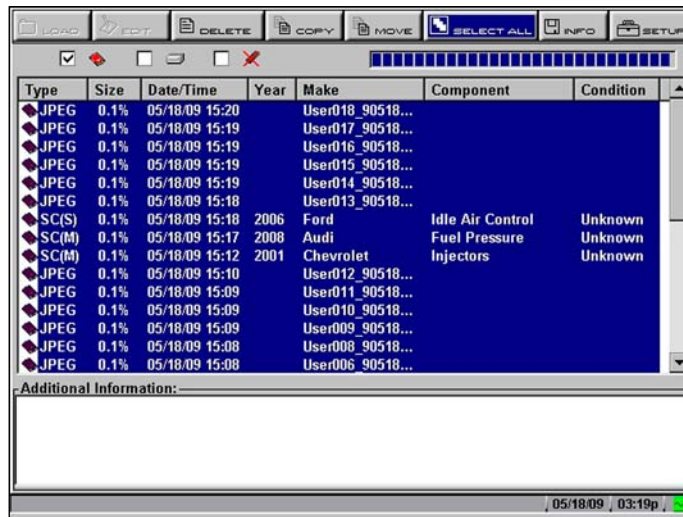

Figure 5-11 Sample **SELECT ALL** screen

## 5.7.7 Viewing Saved Data Information

Selecting the **INFO** button on the toolbar opens a window that provides detailed information about the saved data files, such as the amount of storage memory used and the capacity of the memory storage media (Figure 5-12). Only details for the selected “Save to” destination display.

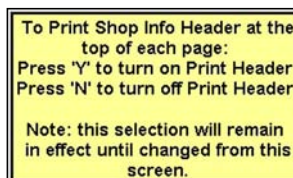

Figure 5-12 Sample **Info** button window

## 5.7.8 Setup

Selecting **SETUP** opens the Save Data dialog box, which allows you to adjust:

- The amount of data saved after a triggering event
- The location where the saved data is stored
- The file type of a saved image



### NOTE:

The Save Data dialog box can also be opened from the MODIS main menu. Refer to “Save Data” on page 39 for details.

## 5.7.9 Backing up Saved Files

You can back up your saved test data to an external source to free internal memory space. Files can be saved to either a CF card in the top slot or a to USB mass storage device (jump drive) connected to the USB port on the top of the unit.



### To back up saved data:

1. Insert a CF card in the top slot.
2. From the main menu, select **Save Data > Data Management**.  
The Data Management screen displays.
3. From the upper toolbar, select **SETUP**.  
The Save Data dialog box displays.
4. Set **Internal** as the **My Data** option and press **N/X** to close the dialog box (Figure 5-13).

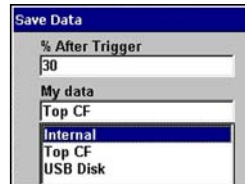

Figure 5-13 Sample Save Data dialog box

5. Press the **SELECT ALL** button to highlight all saved files at once, or highlight an individual file.
6. Select **COPY** or **MOVE** to complete the transfer to the CF card or jump drive.



### To exit the Data Management screen:

- Press **N/X** to return to the main menu.

## 5.8 Utilities

The **Utilities** button accesses system information and various system controls (Figure 5-14).

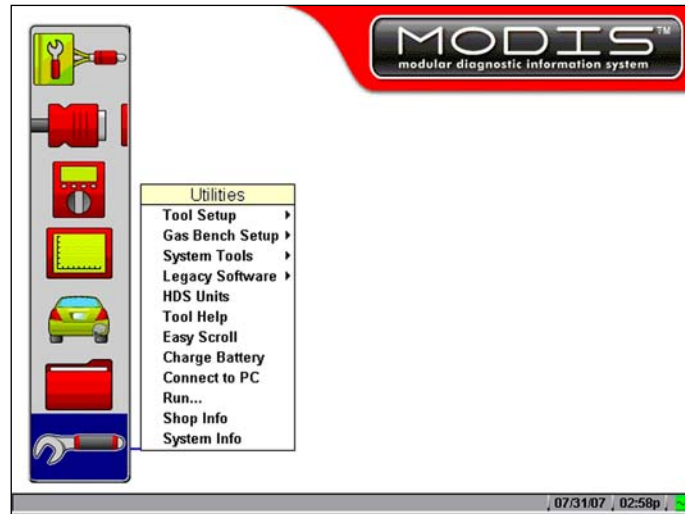

**Figure 5-14** Sample Utilities menu

The following utilities options may be available:

- Tool Setup
- Gas Bench Setup
- System Tools
- HDS Units
- Tool Help
- Easy Scroll
- Charge Battery
- Connect to PC
- Run
- Shop Info
- System Info



**NOTE:**

Depending on the module, some of these utilities are accessible from the Tools button menu on the upper toolbar. Refer to module-specific user manuals for details.

## 5.8.1 Tool Setup

The **Tool Setup** submenu lets you adjust settings for optimum performance.

The Tool Setup submenu may include:

- Units
- Scanner Units
- Ignition System
- Power Management
- Save Data
- Printer

- Date
- Time
- Brightness/Contrast Button
- Navigation Prompts (Europe only)
- Color Theme
- Scanner View
- FGA Demo

## Units

Selecting **Units** displays the Units dialog box (Figure 5-15), which lets you change the units of measurement.

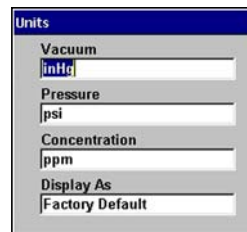

**Figure 5-15** Sample Units dialog box

*Display As* sets how the scale units are displayed (Figure 5-16).

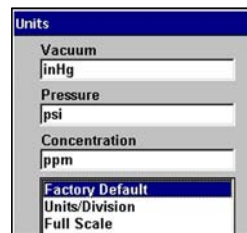

**Figure 5-16** Display As menu sample

For more information refer to the *Lab Scope Plug-in User Manual* or *MODIS™ Flexible Gas Analyzer User Manual*.



### To change the units of measurement:

1. From the main menu, select **Utilities > Tool Setup > Units**.  
The Units dialog box displays (Figure 5-16).
2. Select options from the drop-down lists as necessary.  
The drop-down lists close automatically when **Y/✓** is pressed.
3. Press **N/X** to close the Units dialog box.

## Scanner Units

Selecting **Scanner Units** allows you to switch between US Customary and metric units of measurement for parameter values displayed when using the scan tool.



### To change the Scanner Units:

1. From the main menu, select **Utilities > Tool Setup > Scanner Units**.  
The Scanner Units dialog box displays (Figure 5-17).



Figure 5-17 Sample Scanner Units menu

2. Select options from the drop-down lists as necessary.  
The drop-down lists close automatically when **Y/✓** is pressed.
3. Press **N/X** to close the Units dialog box.

## Ignition System

Available for the Lab Scope Plug-in only, selecting **Ignition System** lets you choose the appropriate setup for the test vehicle, such as ignition type, number of cylinders, firing order, polarity, # 1 trigger, or RPM factor.

Refer to the *Lab Scope Plug-in User Manual* for details.

## Power Management

Selecting **Power Management** lets you change battery pack charging mode settings. Two modes are available for charging the battery pack:

- **Quick**—charges in 4 hours, but puts more strain on the battery pack and reduces its life span.
- **Trickle**—charges in 8 hours and is recommended for maximum battery pack life.

Refer to “Charge Battery” on page 46 for more details.



### To change battery pack charging modes:

1. From the main menu, select **Utilities > Tool Setup > Power Management**.  
The Power Management dialog box displays.
2. Press **Y/✓**.  
A drop-down list displays (Figure 5-18).

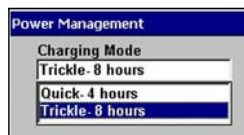

**Figure 5-18** Sample Charging Mode options

3. Select an option from the drop-down list.  
The drop-down list closes automatically.
4. Press **N/X** to close the Power Management dialog box.

## Save Data

Selecting **Save Data** lets you adjust the size of each snapshot and the amount of data recorded after a snapshot trigger point. Refer to the *Lab Scope Plug-in User Manual* for details. **Save Data** also lets you set the saving and loading location for all saved files.



### To adjust snapshot preferences:

1. From the main menu, select **Utilities > Tool Setup > Save Data**.  
The Save Data dialog box displays (Figure 5-19).

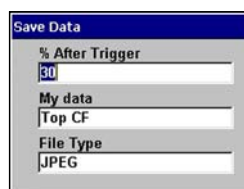

**Figure 5-19** Sample Save Data dialog box

2. Select from the drop-down lists as necessary.  
The drop-down list closes automatically.
3. Press **N/X** to close the Save Data dialog box.



### NOTE:

The Save Data dialog box can also be accessed from the Setup menu on the Save Data management screen. Refer to "Save Data" on page 29 for details.

## Printer

Selecting **Printer** lets you set up your MODIS™ unit for printing to various aftermarket printers.

Settings include:

- Manufacturer—configures the MODIS™ unit to print to different types of printers. Available options include:
  - Hewlett-Packard (HP) PCL 3 (Printer Command Language Level 3) generic driver standard, which supports some HP deskjet and inkjet printers (color and black & white).
  - Seiko DPU-3445 thermal printer.

- Epson ESC/P2 printer command language set, which supports most Epson dot-matrix printers and many inkjet printers (color and black and white).
- Port—lets you activate the MODIS™ port to which your printer is connected.

**NOTE:**

There are several aftermarket IR print adapters available that extend your MODIS™ unit printing. One such compatible third-party adapter is the ACTiSYS model ACT-IR 100M. Contact ACTiSYS Corporation for product details and purchase.

See “Setting Up to Print” on page 16 for more details.

**To adjust printing settings:**

1. From the main menu, select **Utilities > Tool Setup > Printer**.  
The Printer dialog box displays.
2. Select from the drop-down lists as necessary (Figure 5-20).

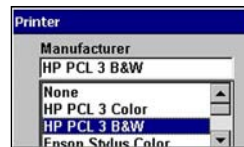

**Figure 5-20** Sample print option menu

The drop-down lists close when **Y/✓** is pressed.

3. Press **N/X** to close the Printer dialog box.

Refer to the user’s manual of the module for printing procedures.

**Date**

Selecting **Date** lets you set the date that displays in the Status bar.

**To set the date:**

1. From the main menu, select **Utilities > Tool Setup > Date**.  
The Date dialog box displays (Figure 5-21).

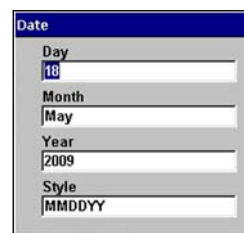

**Figure 5-21** Sample Date dialog box

2. Select from the drop-down lists as necessary.  
The drop-down list closes automatically when **Y/✓** is pressed.
3. Press **N/X** to close the Date dialog box.

## Time

Selecting **Time** lets you set the time that displays in the Status bar.



### To set the time:

1. From the main menu, select **Utilities > Tool Setup > Time**.  
The Time dialog box displays (Figure 5-22).



Figure 5-22 Sample Time dialog box

2. Select from the drop-down lists as necessary.  
The drop-down list closes automatically when **Y/✓** is pressed.
3. Press **N/X** to close the Time dialog box.

## Brightness/Contrast Button

The **Brightness/Contrast Button** utility is used to assign the multi-functional Brightness/Contrast button preference. Function assignment options include:

- **Save Image**—captures a bitmap or JPEG image of any screen during any mode of operation.
- **Freeze/Run**—works as the **Pause/Play** button when viewing data in the graphing views.
- **Save Frame**—this option works like **Save > Save Frame** when available on the upper toolbar.
- **Print List**—Works like **Print > Full PID List** when this option is available on the upper toolbar.
- **Print Page**—depends on which tool and mode of operation you are using. Works like **Print > Screen**, **Print > Full Screen** or **Print > “page name”** when **Print** is an available option on the upper toolbar.
- **Brightness/Contrast**—is the default setting and lets you adjust the brightness and contrast of the screen for optimum viewing.
- **S Button Popup**—opens this menu when the Brightness/Contrast button is pressed so you can quickly select from any of the available functions.



### NOTE:

Using an optional CF card reader/writer connected to your computer, saved bitmap files can be retrieved from your designated storage CF card from the **\User\Data** directory.



### To assign the button function:

1. Select **Utilities > Tool Setup > Brightness/Contrast Button**.  
The Brightness/Contrast dialog box displays (Figure 5-23).



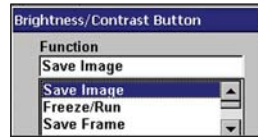

**Figure 5-23** Sample Brightness/Contrast dialog box

2. Select a function from the drop-down list.  
The drop-down lists close when **Y/✓** is pressed.
3. Press **N/X** to close the dialog box.

## Navigation Prompts

Available only in Europe, selecting **Navigation Prompts** lets you set on-screen control button references to match the hardware. Control button references can either display as **Y/N** or **✓/X**.



### To set navigation prompts:

1. From the main menu, select **Utilities > Tool Setup > Navigation Prompts**.
2. The Navigation Prompts dialog box displays (Figure 5-24).

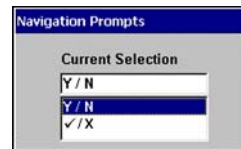

**Figure 5-24** Sample Navigation Prompts dialog box

3. Select a set of control button references from the dropdown list.
4. Press **N/X** to close the dialog box.

## Color Theme

**Color Theme** lets you select a black or white background for the screen.



### NOTE:

Using the black background theme helps conserve battery power.



### To select a Color Theme:

1. Select **Utilities > Tool Setup > Color Theme**.  
The Color Theme dialog box displays.
2. Press **Y/✓** to display the menu (Figure 5-25).



Figure 5-25 Color Theme Menu

3. Select **White Background** or **Black Background**.
4. Press **N/X** to exit the menu.

## Scanner View

Scanner View lets you set how the data displays when you exit and return to the Scanner. Scanner View options include:

- Text
- PID List
- Graph
- Last Used View

Refer to the *MODIS™ Scanner Plug-in User Manual* for details



### To select a Scanner View:

1. Select **Utilities > Tool Setup > Scanner View**.  
The Scanner View dialog box displays.
2. Press **Y/✓** to display a drop-down list (Figure 5-26).

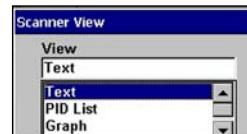

Figure 5-26 Sample Scanner View menu

3. Select an option from the dropdown list, the dropdown list closes automatically.
4. Press **N/X** to close the Scanner View dialog box.

## FGA Demo

Activates a demonstration program for the optional Flexible Gas Analyzer (FGA) module. The program allows you to view simulated test results without connecting to a vehicle.



### To activate the FGA Demo:

1. Select **Utilities > Tool Setup > FGA Demo**  
A check mark now appears on the menu.
2. Navigate to the main menu and select **Gases > Graph/Digital**.  
The demonstration program begins.

## 5.8.2 Gas Bench Setup

Available only in North America, the **Gas Bench Setup** submenu is for use with the optional FGA unit. Refer to the *MODIS™ Flexible Gas Analyzer User Manual* for details.

## 5.8.3 System Tools

The **System Tools** submenu (Figure 5-27) lets you perform system maintenance functions.

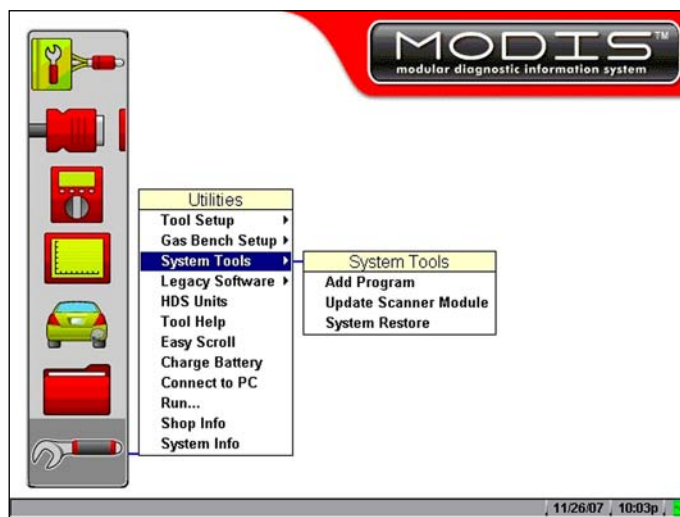

Figure 5-27 Sample System Tools submenu

System Tool options include:

- **Add Program**—lets you add optional software.
- **Update Scanner Module**—When instructed by a Help Desk representative to use, lets you update the Scanner module files.
- **System Restore**—lets you reinstall your system software.

## 5.8.4 Legacy Software

The Legacy Software runs the Scanner Plug-in of your MODIS™ unit using an earlier version of the operating system software. It is used to diagnose older vehicles that are not covered in the current database. Legacy Software also provides an alternate method of connecting to a vehicle when communication problems are encountered.

## 5.8.5 HDS Units

The **HDS Units** utility is for use with the optional Heavy Duty Truck Scanner software, which is only available in North America. Refer to the *MODIS™ Heavy Duty Vehicle Communication Software User Manual* for details.

## 5.8.6 Tool Help

Tool Help provides information from this manual as well as from each of the module-specific manuals currently available with the MODIS™ unit.



### To use Tool Help:

1. From the main menu, select Utilities > Tool Help.  
The Tool Help screen displays.

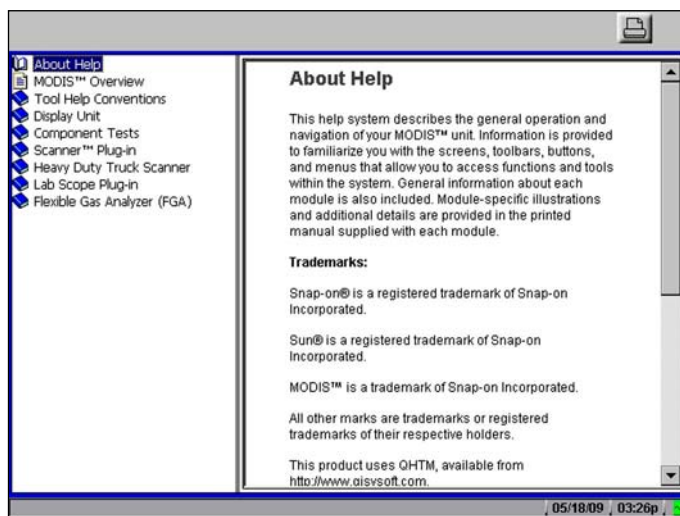

Figure 5-28 Sample Tool Help screen

2. Select a topic from the table of contents frame.  
The topic text displays in the content frame.
3. Press the right ► arrow to move screen focus to the right pane, and press the up ▲ and down ▼ arrows as needed to scroll through additional text not displayed.
4. Press the left ◀ arrow to return to the table of contents frame.



### To expand a table of contents book:

1. Select a book.  
A submenu of related topics displays.
2. Select a topic.  
The topic text displays in the right frame.



### To exit Tool Help:

- Press **N/X** twice.

## 5.8.7 Easy Scroll

The **Easy Scroll** utility functions as a selection shortcut that lets you use only the Thumb Pad arrows to highlight and select an item.

Refer to “Easy Scroll” on page 24 for more information on navigating with Easy Scroll.



To turn Easy Scroll on:

1. Select **Utilities > Easy Scroll** (Figure 5-23).

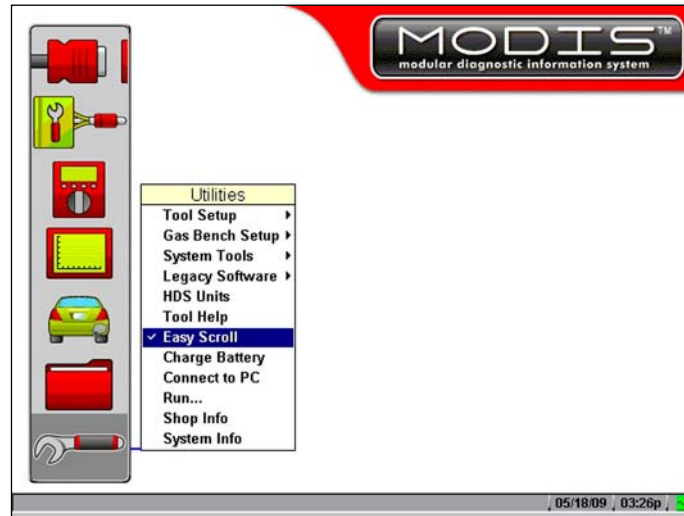

**Figure 5-29** Easy Scroll turned on

A check mark to the right of the Easy Scroll option displays.

2. Repeat step 1 to turn Easy Scroll off.



**NOTE:**

Easy Scroll stays on until you manually turn it off.

## 5.8.8 Charge Battery

Automatic battery pack charging occurs when the following conditions are met:

- The battery pack is installed properly.
- The AC/DC power supply is in use.
- The MODIS™ unit is powered on.





The MODIS™ unit automatically controls battery pack charging.

A Battery/Charging Status indicator icon located on the right side of the status bar (Figure 5-30) shows the charge status.

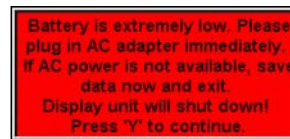

**Figure 5-30** Battery/Charging Status indicator icon sample

**Table 5-1** Power source indicators

Icon	Color	Description
	Green	The unit is either running on external power or the battery pack is charging.
	Blue	The unit is running on a fully charged battery pack.
	Red/Blue	The unit is running on a partially charged battery pack.
	Red	The unit is running on a fully discharged battery pack, a low battery warning message displays and the system shuts down if external power is not connected.

A warning message (Figure 5-31) displays when the MODIS™ battery pack power level is extremely low.

**Figure 5-31** Low battery charge status message

When this message displays, immediately plug in the AC/DC power supply to ensure that the unit continues to operate.

If you do not want to wait for the automatic charging system to start, you can manually activate battery pack charging.



**To manually activate battery charging:**

1. Connect the AC/DC power supply to your MODIS™ unit and plug the other end into an appropriate wall socket.
2. Power on your unit, if needed.
3. Select **Utilities > Charge Battery**.

A check mark to the left of the Charge Battery option indicates the battery is charging.

Refer to “Power Management” on page 38 for details on how to set your charging mode.



**NOTE:**

The check mark may cycle off and on during the charging process due to temperature conditions.

## 5.8.9 Connect to PC

The **Connect to PC** selection is used with the optional ShopStream Connect™ software, which lets you view data files on a computer and share files.

## 5.8.10 Run

Selecting the **Run** option loads authorized software.

## 5.8.11 Shop Info

Select the **Shop Info** option to enter or view ownership information for the unit.



**To enter unit identification:**

1. Select **Utilities > Shop Info**.

The Shop Information dialog box displays (Figure 5-32).

The dialog box is titled "Shop Information" and contains several input fields: "Shop Name", "Address", "City", "State", "ZIP", and "Phone". At the bottom, there is a message: "When finished entering shop information, Press Esc from the keyboard to exit. If a keyboard is not connected, Press 'N' to exit."

**Figure 5-32** Sample Shop Information dialog box.

2. Plug a USB keyboard (not supplied) into the USB port on top of the unit.
3. Type the shop identification information in the available data fields.
4. Press **Esc** to close the dialog box, and unplug the keyboard.
5. Select **Utilities > Shop Info** to verify that the identification information displays properly, and press **N/X** to close the dialog box.

A message offering to include your information as a header on your printed pages displays (Figure 5-33).

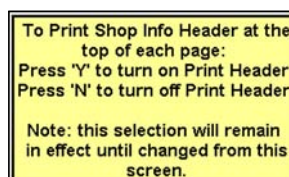

**Figure 5-33** Sample Shop Info header printing message

6. Press **Y/✓** or **N/X** to choose your printing preference.

## 5.8.12 System Info

Selecting the **System Info** option displays configuration information for your MODIS unit.

**To view unit configuration information:**

1. Select **Utilities > System Info**.

The System Information screen displays. The left field of the screen shows the information menu and the right field displays the selected information. Navigate the information screens as follows:

- a. Press the down ▼ arrow to move the highlight from the Print button to the menu.
- b. Use the down ▼ and up ▲ arrows to highlight a menu item.
- c. Press **Y/✓** to select the highlighted menu item.

The selection now displays in the right field of the screen (Figure 5-34).

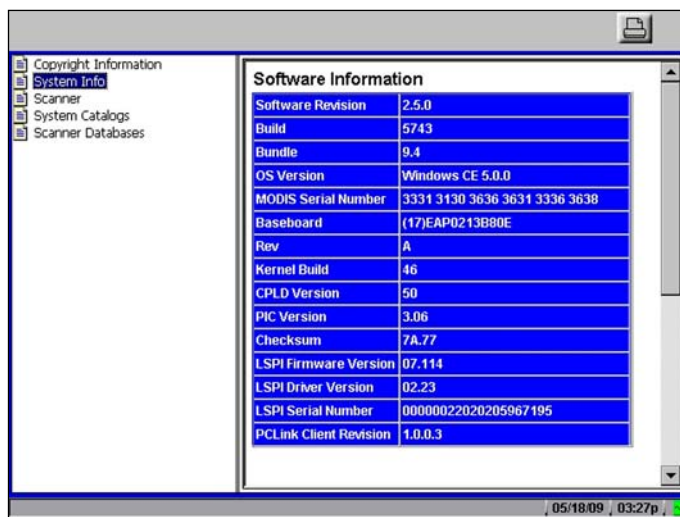

**Figure 5-34** Sample System Information screen

- d. Press the right ► arrow to move from the menu field to the information field.
  - e. Use the down ▼ and up ▲ arrows to scroll the information field.
  - f. Press the left ◀ arrow to return to the menu field.
2. Press the **N/X** twice to exit System Info and return to the main menu.



This section describes maintenance for the following MODIS™ parts and accessories:

- Disposal
- Cleaning and damage inspection
- Battery pack
- 5-amp fuse
- Fan filter
- CompactFlash® (CF) cards
- Liquid Crystal Display (LCD)

## 6.1 Disposal

Products bearing the WEEE logo (Figure 6-1) are subject to separate collection systems in the European Union.



**Figure 6-1** Sample WEEE logo

---

**IMPORTANT:**

Always dispose of materials according to local regulations.

---

Contact your sales representative for details.

## 6.2 Cleaning and Damage Inspection

When using the MODIS™ unit, make sure to do the following:

- Before and after each use, check the housing, wiring, and connectors for dirt and damage.
- At the end of each working day, clean the housing, wiring, and connectors with a soft, clean cloth and gentle all-purpose cleaner.

---

**IMPORTANT:**

Avoid using abrasive or corrosive cleaning products, especially when cleaning the screen. Never allow liquid to enter the unit as this can cause permanent damage.

---

## 6.3 Prolonging Battery Pack Life

To maximize the life expectancy of your battery pack when your MODIS™ unit is not being used, do one of the following:

- Connect the AC/DC power supply, power on your MODIS™ unit, and activate the battery charger to maintain the battery charge.
- Power off your MODIS™ unit and then remove the battery pack.

## 6.4 Replacing the Battery Pack

When your battery pack no longer holds a charge, call your Sales Representative to order a new one to replace it.

---

**IMPORTANT:**

Dispose of the old battery according to local regulations.

---

In North America, contact the Rechargeable Battery Recycling Corporation (RBRC) at 1(800) 822-8837, or refer to their web site at <http://www.rbrc.org> for the nearest recycling location and instructions for proper battery disposal.

**To replace the battery pack:**

1. Remove the old battery pack (Figure 6-2).

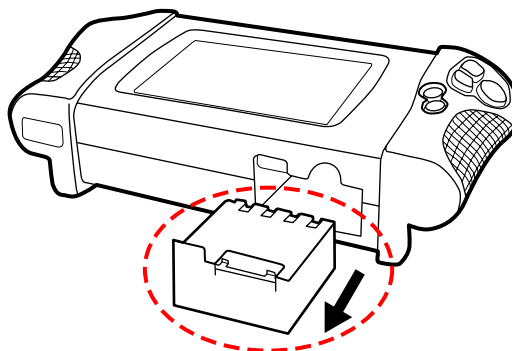
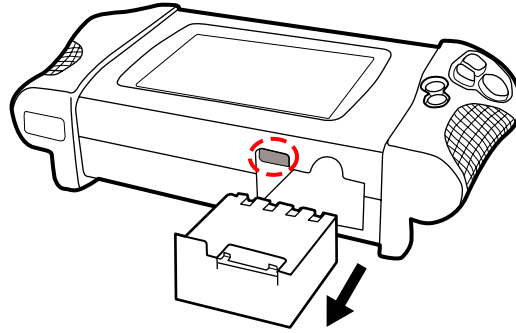

**Figure 6-2** Battery location

2. Insert the new battery pack into the designated slot.
3. Charge the new battery. Refer to “Charge Battery” on page 46 for details.
4. Dispose of the old battery according to local regulations.

## 6.5 5-Amp Fuse

The MODIS™ unit uses one 5-amp automotive fuse to protect the internal circuitry. The fuse is located next to the battery pack on the bottom of the unit (Figure 6-3).



**Figure 6-3** Fuse location

If undamaged, the fuse should never need replacing.

**Follow the precautions below to avoid fuse damage.**

- Do not connect the Scanner™ Plug-in data cable to a car and connect a positive signal from the test vehicle to the common (ground) terminal of the Lab Scope Plug-in.
- Do not reverse the polarity of the auxiliary power connection to a car battery and use the Lab Scope Plug-in.
- Do not replace the 5-amp fuse with a higher rated fuse.



**To replace the fuse:**

1. Turn the MODIS™ unit off.
2. Unplug the power cord and remove the battery pack from the unit.
3. Using needle nose pliers, carefully grasp the fuse and remove it from the unit.
4. Using needle nose pliers, carefully but firmly grasp the new 5-amp fuse and insert it into its proper slot in the MODIS™ unit.

---

**IMPORTANT:**

When inserting a new fuse, do not let it fall into the housing.

---

## 6.6 Fan Filters

The MODIS™ unit uses a filter to reduce dust buildup inside the unit that can reduce screen clarity. The fan filter is located on the back of the unit near the right handgrip (Figure 6-4).

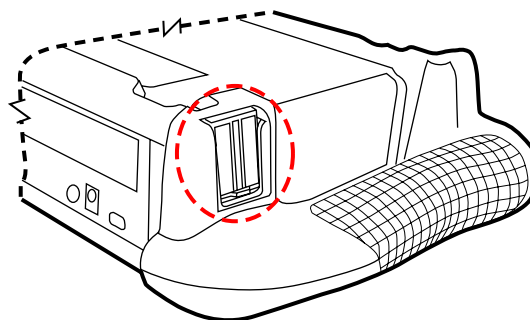

**Figure 6-4** Filter location

**IMPORTANT:**

If the filter becomes clogged, the MODIS™ unit can overheat.

---

Be sure to check the filter periodically to see that the filter is clear. If the filter is clogged, replace it. Your MODIS™ unit comes with spare filters.

## 6.7 CompactFlash® (CF) Cards

Software updates are released on CF card media. Refer to the instructions accompanying the CF card for installation procedures.

---

**NOTE:**

Save your MODIS™ CF cards. They can be used for data storage.

---

## 6.8 Liquid Crystal Display (LCD)

The LCD needs to be handled carefully.

- Clean the LCD with mild detergent and water.
  - Do not place items directly on the LCD surface. Excessive pressure can damage the LCD.
- 

**NOTE:**

Damage caused by improper use or storage is not covered by the standard warranty.

---

The following are solutions for problems that can occur while using your MODIS™ unit.

## Battery Pack

The following conditions may affect your battery pack:

- Battery pack does not charge
- Battery pack discharges during storage
- MODIS™ unit overheats

## Battery Pack Not Charging

If the battery pack does not charge, do the following:

- Check your MODIS™ unit for correct battery pack charging setup. Refer to “Battery Pack” on page 10 for details.
- Wait for your MODIS™ unit to reach the proper temperature. Charging will not occur if the internal unit temperature is below 0 °C/32 °F or over 45 °C/113 °F.
- Manually activate battery charging. Refer to “Charge Battery” on page 46 for details.
- Allow the battery pack to charge in the unit for 48 hours. If the battery pack does not hold the charge, you will need to replace it. Refer to “Replacing the Battery Pack” on page 51. Use another power source to continue working. Refer to “Power Sources” on page 8 for details.

## Battery Pack Discharging During Storage

If the battery pack is in your MODIS™ unit when powered off, a slow discharge occurs. Refer to “Prolonging Battery Pack Life” on page 51 for proper battery pack storage.



### To try to recover a deeply discharged battery pack:

1. Plug in the AC/DC power supply.
2. Power on your MODIS™ unit.
3. Activate the battery charging utility. Refer to “Charge Battery” on page 46 for details.  
Allow the battery pack to charge in the unit for 48 hours. If the battery pack does not hold a charge, you will need to replace it. Refer to “Replacing the Battery Pack” on page 51.

## MODIS™ Unit Overheating

If the internal temperature of your MODIS™ unit reaches 60 °C/140 °F, it powers off automatically.

Overheating can occur under the following conditions:

- Extended use in direct sunlight
- Extended use on hot days
- Extended use in a closed vehicle
- Extended use near a heat source
- Forcing the battery pack to charge when the MODIS™ unit is hot



### **To handle an over temperature shutoff:**

1. Remove the battery pack from your MODIS™ unit.
2. Remove your MODIS™ unit from sunlight or high temperature area.
3. Leave your MODIS™ unit powered off and let it cool down.

## Liquid Crystal Display (LCD) Darkening

Exposure to direct sunlight can cause the liquid crystal in your screen to darken. Darkening is a temporary condition.



### **To return the LCD to normal:**

1. Remove your MODIS™ unit from the sunlight.
2. Let the screen cool down.

# Downloading and Installing Software Updates

Following are instructions for downloading software updates from the internet and installing the updates onto the MODIS™ unit.

## B.1 Check for Service Upgrades Before Use

To download and install software service upgrades you need a personal computer (PC) running ShopStream Connect™ software, which is a free downloadable program.

Improved versions of the operating system software for your handheld diagnostic tool periodically become available at no cost to you. These “service upgrades”, which are the result of an ongoing research and development program, are available through the internet. It is important to check for available upgrades before using your diagnostic tool for the first time, and on a regular basis after that, to ensure you have the latest version of the software.

Following are procedures for:

- Verifying your PC meets the minimum requirements for ShopStream Connect™ software
- Downloading and Installing ShopStream Connect™ software on your PC
- Downloading service upgrades to your MODIS unit

## B.2 Verifying Minimum PC Requirements

---

**IMPORTANT:**

If your PC does not meet the minimum requirements, do not attempt to install the ShopStream Connect software.

---

Before installing the software, verify your PC meets the following requirements:

- System Properties:
  - Operating system—Microsoft Windows 2000 Service Pack 4, Windows XP, or Vista. The system must be upgraded to Microsoft .NET Framework Version 2.
  - Processor—Pentium 4 or later, or equivalent
  - Memory—256 MB minimum, 512 MB recommended
- Hard Drive—50 MB free space
- CD-ROM, DVD, or DVD-ROM drive
- USB 2.0 or later
- Internet Explorer 6.0 or higher
- Internet connection
- Adobe Reader software (free download at [www.adobe.com/products/reader](http://www.adobe.com/products/reader))

A type A/B USB cable is also needed to connect the MODIS unit to the PC.

## B.2.1 Verifying PC System Properties

Follow the procedures below to check your PC system properties and to determine how much free space is available on your hard drive.



**To check your PC system properties:**

1. On the Desktop, right-click **My Computer** to open the menu.
2. Select **Properties** from the menu.

The **System Properties** dialog box displays with your system information (Figure B-1).

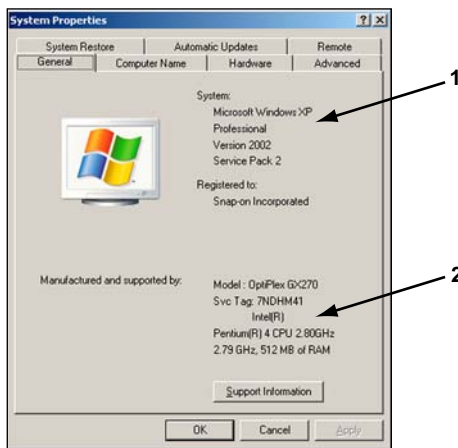

- 1— System property information
- 2— Hard drive information

Figure B-1 Sample Windows XP System Properties dialog box



**To check PC hard drive free space:**

1. On the Desktop, double-click **My Computer**.
2. Select **View > Details** (Figure B-2).

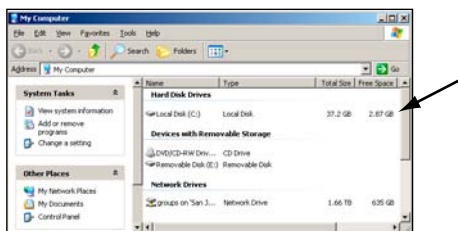

Figure B-2 Sample PC hard drive free space details

## B.3 Downloading and Installing ShopStream Connect

Use the procedure below to download the ShopStream Connect software.





**To download the software:**

1. From your PC, go to <http://diagnostics.snapon.com/scc> using your Internet browser.
2. Locate the ShopStream Connect software download.
3. Follow the on-screen instructions.

After downloading, use the procedures below to install the ShopStream Connect software onto your PC.



**To install the ShopStream Connect software:**

1. Locate the ShopStream Connect software installer on the PC and double-click **ShopStreamConnect.exe**



**NOTE:**

C:\Program Files\ShopStream Connect is the default download location.

2. When the welcome screen displays (Figure B-3), select **Next**.



**Figure B-3** Sample Welcome screen

The License Agreement screen displays (Figure B-4).

3. Highlight **I accept the terms of the license agreement** and select **Next** to continue.

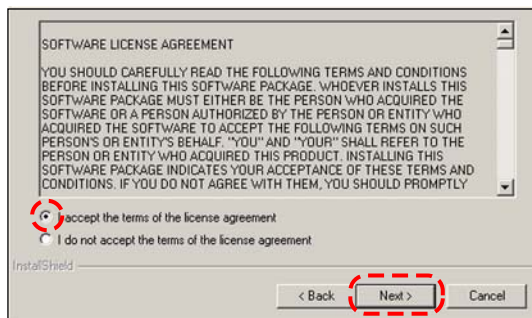

**Figure B-4** Sample License Agreement screen

The Choose Destination Location screen displays. It is highly recommended to allow the software to install in the default location.

4. Select **Next** to continue.
5. Select **Install** when the Ready to Install the Program screen displays to begin the installation.

The Setup Status screen tracks progress as the program installs (Figure B-5).

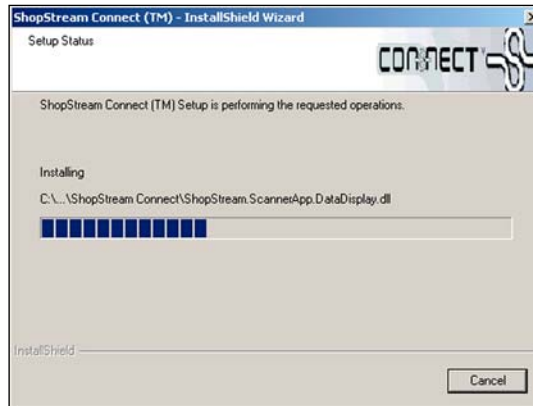

Figure B-5 Sample Setup Status screen

- 6. When the Complete screen displays, select **Finish** to close the Install Wizard (Figure B-6).

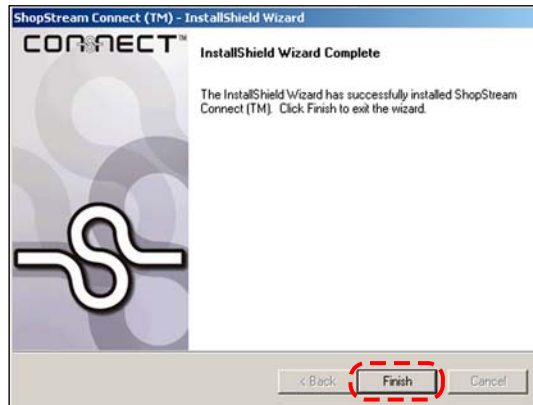

Figure B-6 Sample Complete screen

A ShopStream Connect shortcut icon is added to your desktop (Figure B-7), double-click the icon to launch the ShopStream Connect software.



Figure B-7 Sample ShopStream Connect Desktop icon

## B.4 Downloading Service Upgrades

The ShopStream Connect software allows you to download service upgrades directly to your handheld diagnostic tools, as well as update its own software. The following pages contain a brief

description for installing a service upgrade on a handheld tool. Detailed procedures for updating the ShopStream Connect software, connecting handheld diagnostic tools to the PC, and other operations are found in the ShopStream Connect User’s Manual. The ShopStream Connect User’s Manual is available from the Help button on the ShopStream Connect toolbar (Figure B-8).

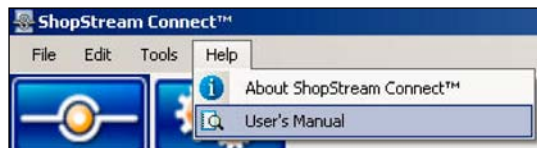

Figure B-8 Sample ShopStream Connect help menu

### B.4.1 Before You Begin

Prior to downloading a service upgrade, be sure to have the following items on hand:

- A PC with ShopStream Connect software and an internet connection
- The AC/DC Power Supply for the MODIS unit
- A type mini A USB cable

---

**IMPORTANT:**

An uninterrupted power source to the diagnostic tool is crucial during an upgrade, as any loss of power may damage the tool and render it inoperative. Therefore, use of the AC/DC Power Supply is highly recommended. Do not rely on partially-charged batteries.

---

### B.4.2 Installing a Service Upgrade

Once you have the required items available, use the procedure below to install an upgrade.



**To install a service upgrade:**

1. Connect the AC/DC Power Supply to the DC power supply input port on MODIS and a reliable power source.
2. Power on the MODIS unit.
3. From the MODIS main menu, select **Utilities > Connect to PC** to place the tool in Connect to PC mode.
4. Remove the left handgrip from the MODIS unit and connect the small end of the USB cable to the port located above the CF card.

---

**IMPORTANT:**

Early production MODIS units do not have a USB port under the handgrip and cannot be updated using this procedure. Contact your sales representative if your unit does not have a USB port.

---

5. Connect the large end of the USB cable to a port on the PC.  
A “Removable Disk” window may automatically open on the PC (Figure B-9). If so, select **Cancel** to close the window.

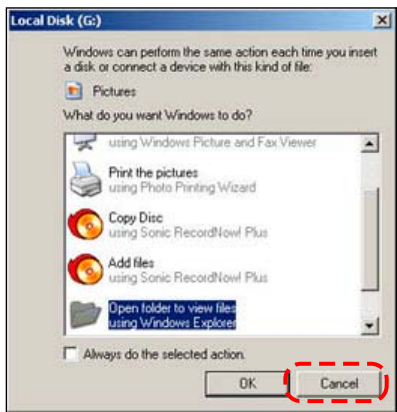

Figure B-9 Sample removable disk window

- 6. Double-click the desktop icon to launch ShopStream Connect (Figure B-7).
- 7. Once ShopStream Connect opens; select Tools > Update Software > MODIS from the Menu bar (Figure B-10).



Figure B-10 Sample Update Software menu

When connectivity is established with the Snap-on Web server, a check for updates confirmation message displays (Figure B-11).



Figure B-11 Sample Check for updates screen

- 8. Select **Next** to continue and the software checks to see if an upgrade is available:
  - a. If no upgrades are available, an updates not found message displays (Figure B-12). Select **Finish** to close the Update Manager, then skip ahead to Step 7.

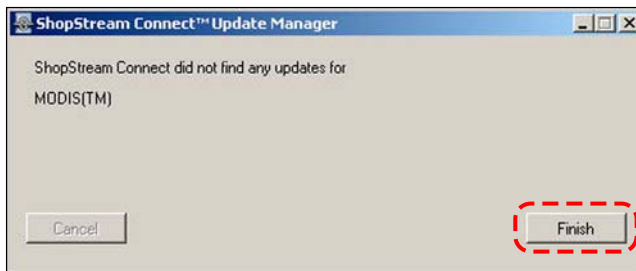

**Figure B-12** Sample no updates available screen

- b. If an upgrade is available, an updates found message displays (Figure B-13). Select **Download** to begin the upgrade process and continue to Step 6.



**Figure B-13** Sample update available screen



**NOTE:**

Each service upgrade is unique. The time involved will vary and some additional steps may be required. Follow any on-screen instructions to complete the process.

9. When the “complete” message displays, select **Finish** to close the Update Manager.
10. Remove the USB cable to disconnect the tool from the PC.
11. Press and hold the **Power** button on MODIS to exit Connect to PC mode.  
The upgrade is now downloaded, but not installed. The installation process automatically begins when MODIS is powered on.
12. Press the MODIS **Power** button to boot the tool and begin the upgrade installation. The install may take several minutes and a series of screens tracks the progress. Do not press any buttons or disrupt power during the installation.  
When the main menu displays, the upgrade installation is complete and your MODIS unit is ready for use.

# Index

## A

AC/DC power supply 8  
add program 44  
adding notes. See editing data

## B

back up saved files 35  
battery pack 10  
  charging 46  
  charging modes 38  
  discharging 54  
  disposing of 51  
  installing 14  
  location 5  
  manual charging activation 47  
  not charging 54  
  specifications 6  
  storage 51  
  supplying charging power 16  
bold text 1  
brightness/contrast  
  adjusting 15–16  
brightness/contrast button 8, 41–42  
  setting function 41  
  utility 41  
button  
  brightness/contrast 8  
  copy 30  
  delete 30  
  edit 30  
  gases 29  
  info 27  
  load 30  
  move 30  
  multimeter 28  
  N 4, 7  
  power 5, 8  
  S 5  
  saved data 29  
  scanner 26  
  scope 28  
  select all 30  
  setup 30  
  utilities 35  
  Y 4, 7

## C

cleaning 50  
Color Theme 42

CompactFlash®  
  and software updates 44  
CompactFlash® card slot, specifications 6  
compatible printers 40  
component testing 27  
Component Tests button 27  
condition, file name 31  
Connect to PC 47

## D

damage inspection 50  
date/time, file 31  
DC power input 5  
deleting data 33  
digital meter 28  
dimensions, unit 6  
display as 37  
display screen  
  maintenance 53  
display, specifications 6

## E

easy scroll 24  
editing data 32  
emissions testing 29  
Epson, printer 40

## F

fan filters 52  
FGA. See Flexible Gas Analyzer  
file types 31  
Flexible Gas Analyzer 29, 44  
fuse  
  location 5  
  replacing 51  
  specification 6

## G

Gases 29  
gases button 29  
graphing meter 28

## H

help. See tool help  
Hewlett Packard 40

- 
- I**
- identifying saved files 31
  - ignition scope 28
  - infrared
    - output 5
    - print adapters 40
- L**
- lab scope 28
  - Lab Scope Plug-in
    - ignition system 37, 38
  - Legacy Software 44
  - loading data 31
- M**
- main body 20
  - main menu 26
  - make, file name 31
  - manual conventions 1–3
  - manuals, additional 3
  - messages 2, 25
    - confirmation 25
    - error 25
    - important 2
    - note 2
    - warning 25
  - MODIS defined 4
  - Multimeter 28
  - multimeter button 28
- O**
- operating temperature 6
- P**
- ports
    - printer 40
    - serial 5
    - USB 5
  - power LEDs 5
  - power sources 8–10
    - AC/DC power supply 8
    - battery power cable 9
    - lighter power cable 9
    - vehicle auxiliary power cables 9
  - printer 39
    - set up 16
  - printer, manufacturer 39
  - printing
    - and infrared output 5
    - and serial port 5
    - compatible printers 16
    - connecting a printer 39
    - third party adapters 40
    - procedures 2
- R**
- run 48
- S**
- Safety iii–iv
    - safety
      - information iii
  - save bitmap 41
  - Save Data 29
  - saved data button 29
  - saved files
    - backing up 35
    - copying and moving 33
    - deleting 33
    - editing 32
    - identifying 31
    - loading 31
    - selecting all 34
  - scanner
    - button 26
  - Scanner View 43
  - Scanner™ Plug-in
    - data cable 10, 13
  - Scope 28
    - scope button 28
  - screen display
    - darkening 55
  - screen layout 19–23
  - screen messages 25
    - confirmation 25
    - error 25
    - warning 25
  - Seiko, printer 39
  - selections, making 23
  - sensor, file name 31
  - serial port 5
  - setup
    - save data 35
  - setup. See tool setup
  - shop info 48
    - header printing 48
  - ShopStream Connect 16
  - size, file name 31
  - snapshot preferences, adjusting 39
  - software updates 53
  - stand, the 7
  - status bar 23
  - storage temperature 6
  - symbols 1
  - system info 48
  - system restore 44
-

system tools 36, 44  
  add program 44  
  system restore 44  
  update scanner module 44

**T**

temperature  
  operating 6  
  storage 6  
terminology 2  
Thumb Pad 4, 8  
tool help 3, 45  
tool setup 36, 36–41  
  date 40  
  ignition system 38  
  power management 38  
  printer 39  
  save data 39  
  time 41  
  units 37  
toolbars 20–23  
  lower 22  
  navigating 20  
  upper 20  
type, file name 31

**U**

units 37  
  display as 37  
update scanner module 44  
USB port 5  
utilities 35–49  
  brightness/contrast button 41  
  charge battery 46  
  easy scroll 45  
  gas bench setup 44  
  HDS units 44  
  Run 48  
  system info 48  
  system tools 44  
  tool help 45  
  tool setup 36  
utilities button 35  
Utilities menu  
  Color Theme 42  
  Connect to PC 47  
  Legacy Software 44  
  Scanner View 43

**V**

vehicle auxiliary power cables 9  
VGA output 5

**W**

weight, unit 6

**Y**

year, file name 31